



Design of a Lab-built Fully Automated Microfluidic Fluorometric System for Fluorescent Dye Applications

Maitham Najim Aboud* and K. H. Al-Sowdani

Chemistry Department, College of Education for Pure Sciences, University of Basrah, Basrah, Iraq.

*Corresponding Author Email: maytham.abood@uobasrah.edu.iq

Received 04 August 2023, Revised 06 September 2023, Accepted 23 January 2024

Abstract

Microfluidics can process small amounts of fluids by using microscopic channels with microscale dimensions ranging from tens to hundreds of micrometers. Many researchers have recently been working on smaller analytical equipment, such as micro flow cytometers. These gadgets offer numerous advantages, including portability, low cost, and low power consumption. It can also be integrated with other microfluidic devices for multitasking applications. In this study, the fluorescein dye was estimated using a lab-built fully automated microfluidic fluorometric system. The developed system contained a microfluidic chip with two lines, each four centimetres long and with a volume of 15 μL . In this setup, two Arduino UNO (R3 version) microcontrollers were programmed using homebrew software. The first was to manage the two improvised peristaltic pumps, which successfully introduced the fluorescein dye to the water stream automatically, replacing the manual injection. The volume of the fluorescein sample was modified by varying the fluorescein line's run time. The second one was utilized to record the output signal. The method accurately identified fluorescein concentrations up to 0.01 $\mu\text{g/mL}$ and 0.999 as a regression coefficient for six points. The RSD% (Relative Standard Deviation) for ten 0.08 $\mu\text{g/mL}$ fluorescein measurements was 0%, and the detection limit was 1×10^{-4} $\mu\text{g/mL}$. The suggested method can measure 300 samples per hour while decreasing the amounts of reagents and waste. This microfluidic fluorometric system has the potential to be used for fluorescent dye assays in a variety of applications.

Keywords: Automation instruments, Microfluidic applications, Lab-made microfluidic, Fluorometric system, fluorescein dye

Introduction

In the last 15 years, the microfluidic field has been one of the most rapidly rising branches of technological and scientific research, with the events of these studies increasing significantly, as evidenced by published papers in this field. Microfluidics technique has emerged in various technical developments in a very short period [1,2]. This idealized method includes sample treatment, analysis, lower reactant volume, reaction and separation periods [3-5]. Because of microchannels and compactness, microfluidic

devices enable us to efficiently manipulate the separation environment, which has been widely employed as a tool in this segment [6-8]. Hence, due to the microfluidics potentialities, the flow automation system's methods are well recognized in analytical chemistry. Automation makes microfluidic systems an attractive option for analysis by minimizing costs and risks, managing high throughput analysis, and lowering contamination risk. It also decreases human errors while increasing precision and

reproducibility [9-13]. Microfluidic techniques have been successfully applied in biotechnology [14-16]. Microfluidic scientific technology deals with tiny channels with small fluid volumes ranging from tens to hundreds of micrometres up to (10^{-9} - 10^{-18} L). The most repetitive, routine, and time-consuming job was manually injecting samples into the carrier stream of flow injection analysis FIA and microfluidic devices [17,18]. Therefore, in the present work, it was decided to replace it by automatically introducing the sample using an open source, offered with handmade software. In this investigation, two microcontrollers UNO Arduino types were used, one to control the speed of the built mini-pump and the other to select the appropriate volume of sample by varying the run time. The other microcontroller served as a data recorder, using a custom Software Lab Fluorometric Signal (LFS) to measure the fluorescence signals. The data were shown as peaks on a laptop using Microsoft Excel 2016 to record the signals as peak height, which corresponded to the fluorescein sample concentration [19-26]. Fluorescence in chemical compounds has a variety of valuable functions and applications, including mineralogy, chemical sensors (fluorescent technique), medicine, dyes compounds, fluorescent labelling medical detectors, and fluorescent lamps in general [27-29]. One of the primary benefits of flow analysis is that it is easily automated. The great reliance on automating chemical analyses, including the delivery of reagents and samples by electromechanical procedures linked to microcomputers, makes these systems automated [30,31]. Currently, electronic manifolds, novel materials, and fabrication methods, such as 3D printing, are being used to figure out and develop flow system devices, which offer some advantages over predictable manufacturing techniques, allowing for the fast and effective fabrication of refined

devices [32]. One of the critical phases in automating flow analysis systems is controlling flow direction and rate with programmable peristaltic pumps [33]. Food safety analysis demonstrates that it plays a significant role in governing food corruption and management. Many effective strategies for multiplex optical bioassays (MOBAs) such as microfluidic chips, microplate, signal-resolution modes, and SPR chips were used to distinguish luminescence, fluorescence, colorimetric, surface plasma resonance as signal tags, and in the case of enhancing complex capacity and detection throughput. Microfluidic selection chips with multichannel manner would be a promising method to overcome the physical limits of immunochromatographic elucidation. Microfluidics is a highly competent and sensitive technology that has many advantages in the detection of food pollutants such as foodborne pathogens, heavy metal ions, pesticides, toxic materials, and so on, especially when combined with a variety of submicron fluid powerful methods, making food analysis and detection more accurate and efficient [34,35]. The goal of this study is to create a tiny fluorimeter as a detector for a fully automated microfluidic system using components accessible on the local market and 3D printers.

Materials and Methods

Materials

All solutions were made with deionized/distilled water, which were used throughout the experiment. The peak height was the average of three subsequent peaks. Fluorescent solution (0.01 mol/L) was made by dissolving (0.332 g) of fluorescein material in a litre of distilled water, and the stock fluorescein sodium salt dye solution of 0.001 mol/L was made by dissolving 0.094 g in an appropriate amount of deionized distilled water, and then the volume

was made up 250 mL, and then this stock solution was diluted to a series of concentrations. The working solutions were prepared on a daily basis and kept in the dark in the container covered with an aluminium foil to prevent photo-degradation. The measured value was the average of three successive peak heights [36,37].

Instrumentation

The chips for microfluidics

The Microfluidic chips were made of Polydimethylsiloxane (PDMS) (double-line microfluidic chips), and the two channels were drilled with a tool (RONGXIN). The volume of the channels was measured using a Hamilton syringe and concentrated fluorescein dye. The volume was 15 μL for each channel, with a total volume of 30 μL for both the carrier stream and the fluorescein sample (Fig. 1).

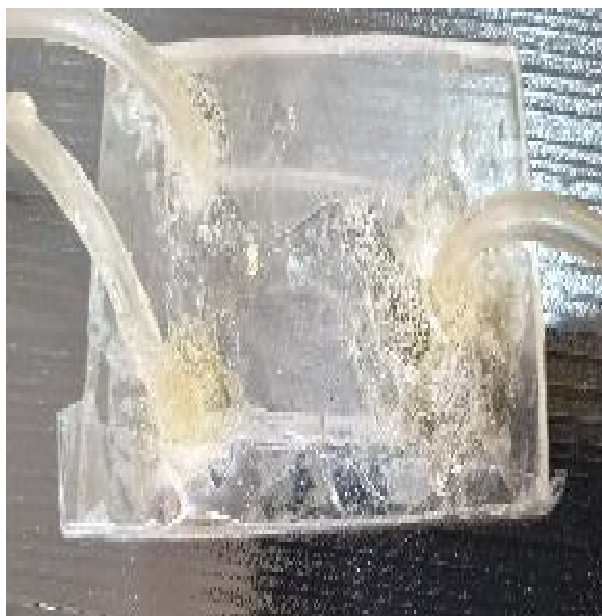

Figure 1. The Microfluidic chips designed for automation system.

Mini-Pump

The components used in the design of the two peristaltic pumps (INTLLAB 12V DC DIY) for withdrawing carrier and

reagent controlled with Driver Motor (L298N) are shown in Fig. 2(a). The two Arduino UNO microcontrollers were utilized, the first to manipulate the two lab-made peristaltic pumps and the second for using a homemade program; Lab Fluorometric Signal (LFS). The device power control was maintained by Power supply, On/off button, and Two button Air suction.

Lab-made Fluorimeter

Fig. 2(b) shows the key components of the laboratory-made fluorimeter. It was made up of LED lamp 28 V as a source, Flow cell 450 μL (Helmma), Photocells sensor as a detector, and an Arduino microcontroller to work as a data logger to record the peak height on the screen of a laptop supplied with Microsoft Excel 2016 that corresponds to fluorescein concentration [22-26].

Procedure

Fig. 3 depicts the manifold utilized by the lab-built Fluorometric microfluidic system to fully automate the determination of fluorescein. The volume of fluorescein was changed through adjusting the sucking time by selecting the appropriate run time from the program view. The fluorescein sample was mixed with the carrier stream (water) by sucking it into the chip and allowing it to pass through the flow cell. The diode LED detector was used to measure the fluorescein signal. This data was recorded on the laptop using a microcontroller and homemade software to function as a data logger. The result was produced as peaks with heights proportional to fluorescein concentrations. For several seconds, which was controlled by the UNO microcontroller via the program Lab LFS. The dual-channel microchip was utilized to transport the material to the flow cell, which was installed in the lab-built fluorimeter.

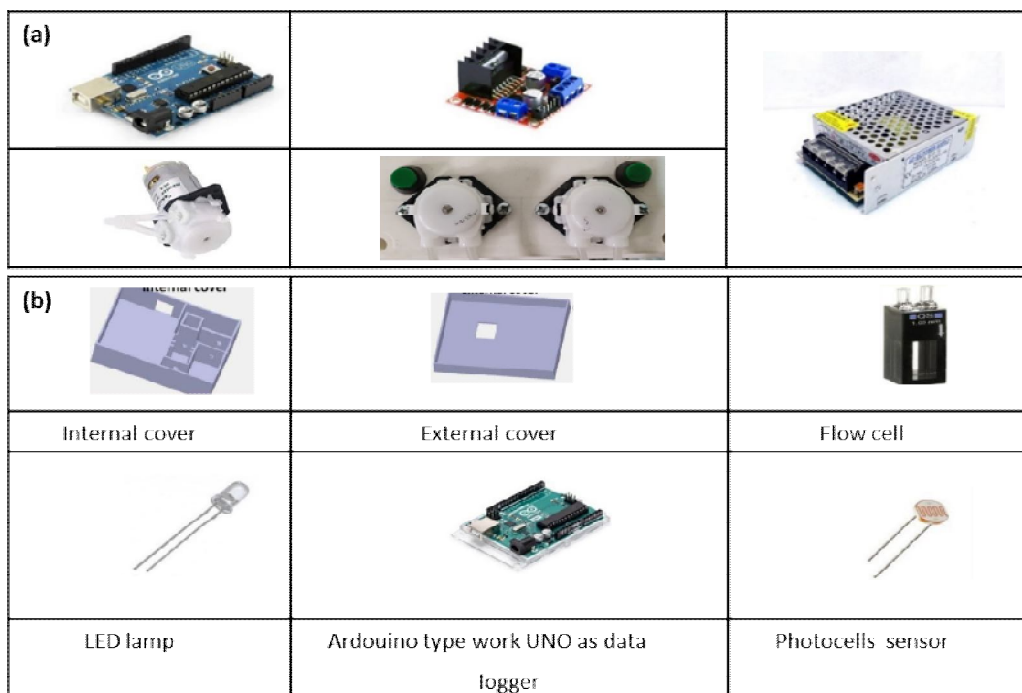

Figure 2.(a) Components of lab - built mini peristaltic pump,(b) Components of lab -built Fluorometer

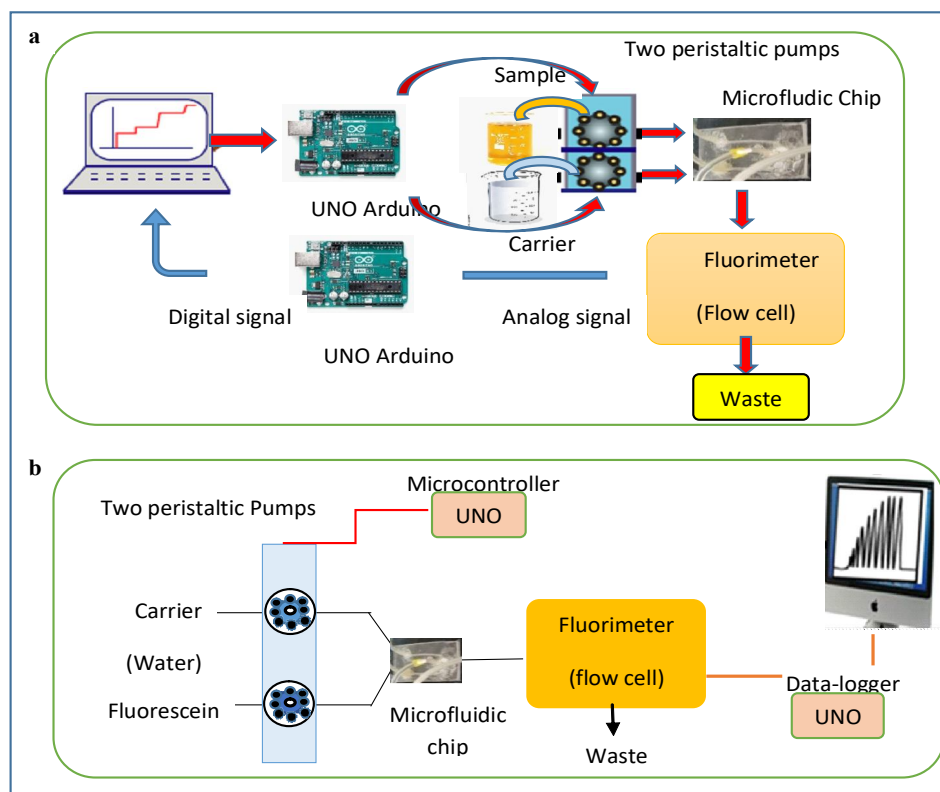

Figure 3. (a) Fully automated microfluidic flow injection fluorometric system, (b) Manifold used to determine the fluorescein.

Results and Discussion

The Conditions

A few reports showed that one of the fluorescent spectra depicted a maximum emission wavelength of 512 nm and a maximum excitation wavelength of 494 nm [32-34]. In order to achieve excellent performance, the physical and chemical characteristics of the lab-made fully automated microfluidic system were altered [23]. The flow rate is an important physical parameter, particularly in microfluidic devices. Fig. 4(a and b) shows the effect of a flow rate of the carrier stream (water) on the peak height of (0.08 $\mu\text{g/mL}$) Fluorescein. In the range illustrated in Fig. 4, peak height increases with decreasing flow rate; 2 mL/min was chosen for further investigation. This is due to the increased dispersion in the microfluidic system caused by the mixing of

108 μL of Fluorescein sample. This set volume of samples was handled by selecting the appropriate sucking time using a UNO microcontroller (R3) paired with custom software [33,35]. Fig. 5(a and b) shows that extending the sucking time increases the peak height, which can be attributed to increasing the sample volume and decreasing the dispersion in the flow system at the previously measured flow rate [37,38]. As a result, 108 μL was employed in the next experiment to achieve good sensitivity and high sample flow. Fig. 6(a and b) shows the results obtained in the 10-100 cm tube length (0.2 mm i.d.) range, indicating that extending the tube length leads to higher mixing of the fluorescent sample inside the carrier stream. To ensure that the peak height decreases with increasing tube length, a length of 10 cm has been chosen for future work.

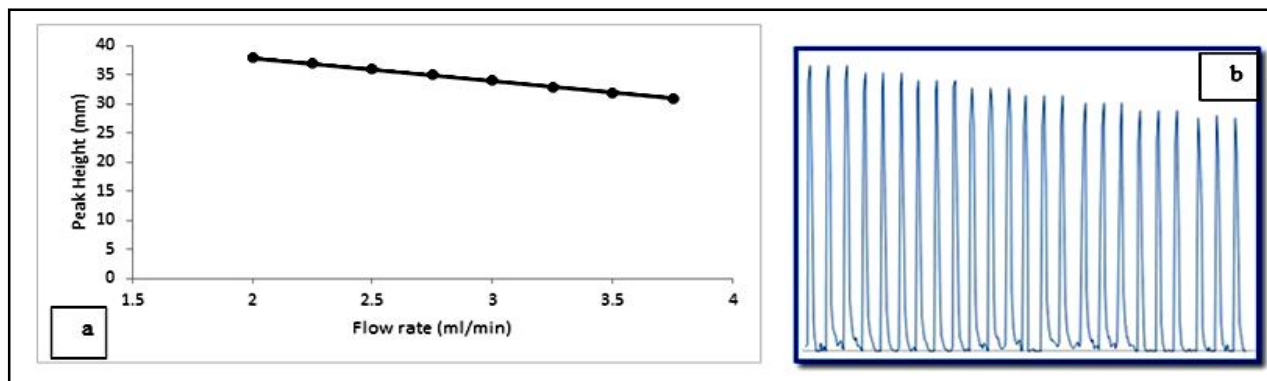

Figure 4. (a) Effect of flow rate on peak height, (b) Peaks obtained by using the system

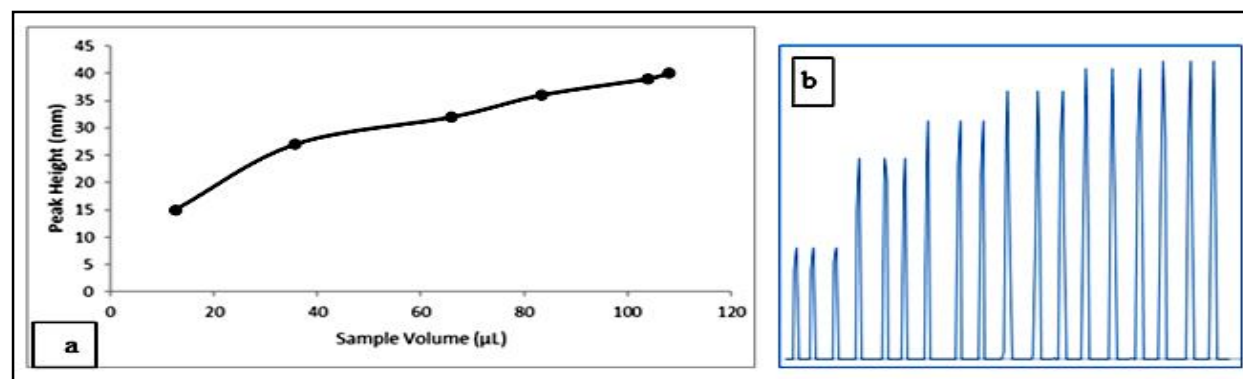

Figure 5. (a) Effect of the Sample volume on the peak height, (b) Peaks obtained from the system

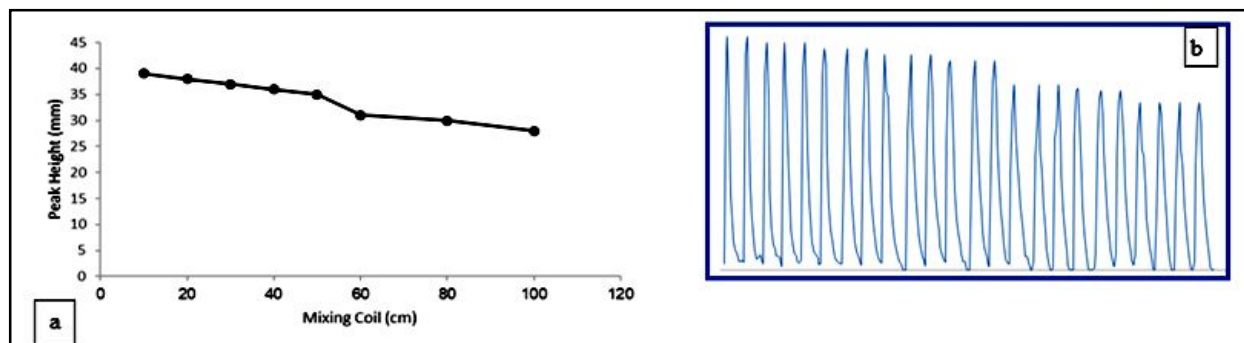

Figure 6. (a) Effect of the tube length on the peak height, (b) Peaks obtained from the system

Standard calibration graph (curve)

In accordance with the set conditions indicated in Table 1. The linearity range was found to be between $0.002\text{--}0.01\ \mu\text{g}/\text{mL}^{-1}$, as shown in Fig. 7(a and b). The five-point regression coefficient was 0.999, the RSD% for ten replicates of $0.01\ \mu\text{g}/\text{mL}$ fluorescent was 0.0%, the detection limit was $0.0001\ \mu\text{g}/\text{mL}^{-1}$, and the dispersion in the proposed system was 1.055. The relationship between the peak height and the concentration is given by the equation $y = 5150x - 0.5$, where y and x are the peak height and fluorescent concentration, respectively, and $R^2 = 0.999$ is the regression coefficient. The sample rate was 300 samples per hour and each sample required (0.025 mL) of $0.008\ \mu\text{g}/\text{mL}^{-1}$ fluorescent (Figure 8 a and b).

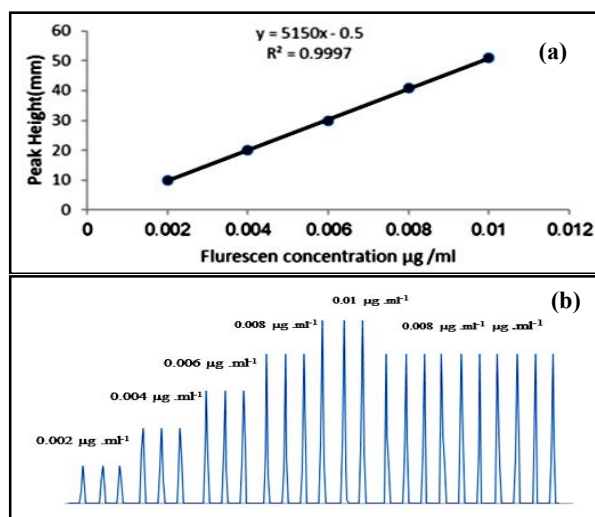

Figure 7. (a) Calibration plot for fluorescein, (b) The obtained peaks of the current design system

Table 1. Optimum conditions for Fluorescein determination.

Parameters	Values
Total flow rate	0.5 mL/min
Chip volume	20 μL
Fluorescein conc.	$0.008\ \mu\text{g}/\text{mL}^{-1}$
Sample volume	25 μL
Tube diameter	0.2 mm

Accuracy

The conventional adds approach was employed to investigate the suggested system's correctness. Three fluorescent dye representative samples were measured. Fig. 8(a) and Table 2, illustrate the result achieved for sample one; this result clearly revealed that the system's accuracy was within the correct statistical results [39-41]. The accuracy of current results for the designing system was evaluated by comparing them to a previous study done by Namea and Al-Sowdani in 2020 [36], which clearly displays a comparison found that using a designed automated system increased sample throughput and linearity, as well as the results acquired in a simple, rapid, and reliable manner.

Dispersion Coefficient

Fig 8. (b) depicts the calculation of the dispersion coefficient in the proposed system's manifold, which was 1.055.

$$D = H^*/H_{max} ; D = \frac{37.99}{36.0} = 1.055$$

Table 2. The recovery studying standard addition method.

Sample	Added ($\mu\text{g/mL}^{-1}$)	Found ($\mu\text{g/mL}^{-1}$)	*Recovery
1	0.0015	0.0015	100 \pm 0.0
2	0.0025	0.0025	102 \pm 0.0
3	0.0035	0.0035	100 \pm 0.0

* The RSD for all results above equal to zero

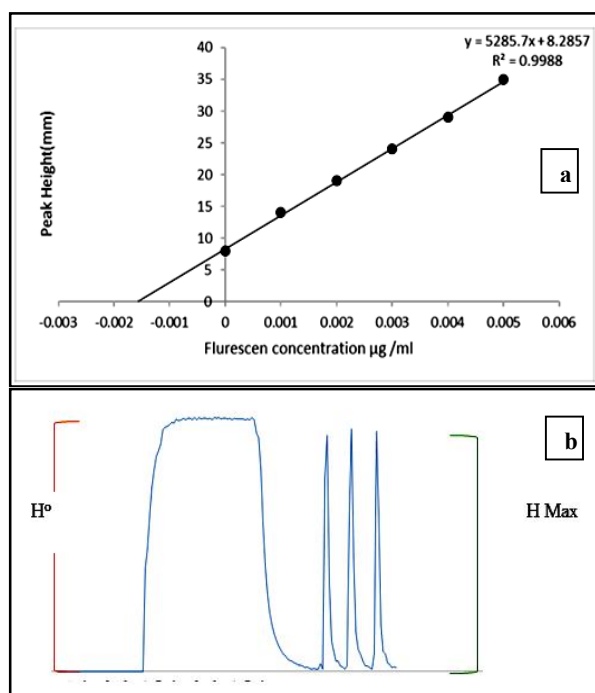

Figure 8. (a) Fluorescein (standard addition method), (b) dispersion coefficient

Conclusion

The proposed approach was effectively used to determine fluorescent dye samples using the standard addition method, with no interface effects. We used the standard addition procedure, which proved to be fairly accurate. It has several features that make it easy to use, such as speed, simplicity, high sensitivity, automation, and environmental friendliness, which makes it effective and low cost. This will allow us to study and analyze

other fluorescent compounds as well as various disciplines of chemistry, including biochemistry and biology research. In the future, such as adding a biosensor guideline based on peptide aptamers for spatial recognition of comparing protein markers of infections in natural fluids or fabricating a microfluidic framework of a given topology for label-free fluorimetric discovery of protein structures, and we can even add more mini pumps to study the fluorescent.

Acknowledgment

We'd like to express our gratitude to the Chemistry Department, College of Education for Pure Sciences, University of Basrah, Basrah, Iraq for supporting us and using their facilities to conduct our research analysis. This research is a part of PhD graduate research project.

Conflict of Interest

The authors declare that they have no competing interests.

References

1. A. Farahinia, W. Zhang and I. Badea, *Sensors (Basel)*, 23 (2023) 5300. <https://doi.org/10.3390/s23115300>. PMID: 37300027.
2. M. P. Bhat, V. Thendral, U. T. Uthappa, K. H. Lee, M. Kigga, T. Altalhi, M. D. Kurkuri and K. Kant, *Biosensors (Basel)*, 12 (2022) 220. <https://doi.org/10.3390/bios12040220>.
3. J. Hur and A. J. Chung, *Adv. Sci. (Weinh)*, 8 (2021) e2004595. <https://doi.org/10.1002/adv.202004595>.
4. L. R. G. Palacios and A. G. Bracamonte, *RSC Adv.*, 12 (2022) 12806. <https://doi.org/10.1039/d2ra02008d>.
5. M. Asghar, M. Yaqoob, N. Munawar, and A. Nabi, *Anal. Sci.*, 32 (2016) 337.

6. <https://doi.org/10.2116/analsci.32.337>. N. Xiang and Z. Ni, *Biosensors (Basel)*, 13 (2023) 161. <https://doi.org/10.3390/bios13020161>. PMID: 36831927.
7. C. Özyurt, I. Uludağ, B. İnce and M. K. Sezgintürk, *J. Pharm. Biomed. Anal.*, 226 (2023) 115266. <https://doi.org/10.1016/j.jpba.2023.115266>.
8. N. Lu, H. M. Tay, C. Petchakup, L. He, L. Gong, K. K. Maw, S. Y. Leong, W. W. Lok, H. B. Ong, R. Guo, K. H. H. Li and H. W. Hou, *Lab. Chip*, 23 (2023) 1226. <https://doi.org/10.1039/d2lc00904h>.
9. M. F. Razuc, M. Grünhut, E. Saidman, M. Garrido and B. F. Band, *Talanta*, 115 (2013) 314. <https://doi.org/10.1016/j.talanta.2013.05.002>.
10. S. Meseguer-Lloret, S. Torres-Cartas and M. C. Gómez-Benito, *Anal. Bioanal. Chem.*, 398 (2010) 3175. <https://doi.org/10.1007/s00216-010-4227-1>.
11. D. Meneses, J. G. F. Júnior and P. C. C. de Oliveira, *Environ. Monit. Assess.*, 190 (2018) 617. <https://doi.org/10.1007/s10661-018-6984-9>.
12. M. D. V. Mishima, B. P. da Silva, M. J. C. Gomes, R. C. L. Toledo, C. E. R. Pereira, N. M. B. Costa and H. S. D. Martino, *Eur. J. Nutr.*, 62 (2023) 905. <https://doi.org/10.1007/s00394-022-03043-2>.
13. T. Wang, C. Yu and X. Xie, *Adv. Biochem. Eng. Biotechnol.*, 179 (2022) 267. https://doi.org/10.1007/10_2020_128.
14. S. Sart, G. Ronteix, S. Jain, G. Amsellem and C. N. Baroud, *Chem. Rev.*, 122 (2022) 7061. <https://doi.org/10.1021/acs.chemrev.1c00666>.
15. J. Y. Tan, T. E. Saleski and X. N. Lin, *PLoS One*, 17 (2022) e0266282. <https://doi.org/10.1371/journal.pone.0266282>.
16. V. Ortseifen, M. Viefhues, L. Wobbe and A. Grünberger, *Front. Bioeng. Biotechnol.*, 8 (2020) 589074. <https://doi.org/10.3389/fbioe.2020.589074>.
17. J. Wu, H. Fang, J. Zhang and S. Yan, *J. Nano Biotechnol.*, 21 (2023) 85. <https://doi.org/10.1186/s12951-023-01846-x>.
18. Y. J. Al-Jorani, K. H. Al-Sowdani and M. Salah, *J. Phys. Conf. Ser.*, 1818 (2021) 012050. <https://doi.org/10.1088/1742-6596/1818/1/012050>.
19. I. A. Al-Asady and K. H. Al-Sowdani, *J. Phys. Conf. Ser.*, 2063 (2021) 012018. <https://doi.org/10.1088/1742-6596/2063/1/012018>.
20. K. H. Al-Sowdani and M. K. Al-Balaawi, *J. Phys. Conf. Ser.*, 1294 (2019) 072010. <https://doi.org/10.1088/1742-6596/1294/7/072010>.
21. S. Al-Omran and K. H. Al-Sowdani, *J. Basrah Res. Sci.*, 35 (2009) 61.
22. Y. Al-Jorani and K. H. Al-Sowdani, *IOP Conf. Ser. Mater. Sci. Eng.*, 871 (2020) 012032. <https://doi.org/10.1088/1757-899X/871/1/012032>.
23. J. Monahan, K. A. Fosser, A. A. Gewirth and R. G. Nuzzo, *Lab Chip*, 2 (2002) 81. <https://doi.org/10.1039/b111449b>.
24. K. H. Al-Sowdani and A. H. Noor, *Int. J. Sci. Res.*, 11 (2016) 189. <https://doi.org/10.21275/ART20162631>.
25. M. Trojanowicz and M. Pyszynska, *Molecules*, 27 (2022) 1410. <https://doi.org/10.3390/molecules27041410>.
26. A. K. Gaigalas, L. Wang and R. F. Vogt, *Photochem. Photobiol.*, 76 (2002) 22.

- [https://doi.org/10.1562/0031-8655\(2002\)076<0022:FDMOTP>2.0.CO;2](https://doi.org/10.1562/0031-8655(2002)076<0022:FDMOTP>2.0.CO;2)
27. D. E. Zacharioudaki, I. Fitis and M. Kotti, *Molecules*, 27 (2022) 4801. <https://doi.org/10.3390/molecules27154801>.
 28. J. Oxer and H. Blemings, 1st Edition, *Practical Arduino: Cool Projects for Open Source Hardware (Technology in Action)*, Apress Berkeley, CA (2009) 43. ISBN-10 :1430224770
 29. B. A. Mathieu, Multi-Parameter Quantitative Mapping of Microfluidic Devices, University of Edinburgh Scotland, UK, PhD dissertation (2011). <http://hdl.handle.net/1842/5739>.
 30. C. Vakh, M. Falkova, I. Timofeeva, A. Moskvina, L. Moskvina and A. Bulatov, *Crit. Rev. Anal. Chem.*, 46 (2016) 374. <https://doi.org/10.1080/10408347.2015>.
 31. A. Gioiello, A. Piccinno, A.M. Lozza and B. Cerra, *J. Med. Chem.*, 63(13) (2020) 6624. <https://doi.org/10.1021/acs.jmedchem.9b01956>.
 32. C. Pasquini and L. C. de Faria, *J. Automat. Chem.*, 13 (1991) 143. <https://doi.org/10.1155/S1463924691000275>.
 33. N. Shi, M. Mohibullah and C. J. Easley, *Annu. Rev. Anal. Chem.* 14 (2021) 133. <https://doi.org/10.1146/annurev-anchem-122120-042627>.
 34. N. Hao and K. Wang, *Anal. Bioanal. Chem.*, 408 (2016) 7035. <https://doi.org/10.1007/s00216-016-9548-2>.
 35. Z. Xie, H. Pu and D.W. Sun, *Compr. Rev. Food Sci. Food Saf.*, 20 (2021) 3818. <https://doi.org/10.1111/1541-4337.12766>.
 36. A. S. Namea and K.H. Al-Sowdani, *Eur. J. Mol. Clin. Med.*, 7 (2020) 3818. <https://ejmcm.com/issue-content/lab-build-very-simple-fluorimeter-flow-injection-system-with-assistance-of-3d-printer-5227>
 37. X. F. Zhang, J. Zhang and L. Liu, *J. Fluoresc.*, 24 (2014) 819. <https://doi.org/10.1007/s10895-014-1356-5>.
 38. Z. Guo-Qi, L. Yong-Sheng, Z. Yang, L. Ya-Xiong and G. Xiu-Feng, *Microchem. J.*, 155 (2020) 104698. <https://doi.org/10.1016/j.microc.2020.104698>
 39. N. Sitkov, T. Zimina, A. Kolobov, V. Karasev, A. Romanov, V. Luchinin and D. Kaplun, *Micromachines (Basel)*, 12 (2021) 691. <https://doi.org/10.3390/mi12060691>.
 40. N. Sitkov, T. Zimina, A. Kolobov, E. Sevostyanov, V. Trushlyakova, V. Luchinin, A. Krasichkov, O. Markelov, M. Galagudza and G. Kaplun, *Micromachines (Basel)*, 13 (2021) 20. <https://doi.org/10.3390/mi13010020>.
 41. Z. Guo-Qi, L. Yong-Sheng, Z. Yang, L. Ya-Xiong, and G. A. Xiu-Feng, *Microchem. J.*, 155 (2020) 104698. <https://doi.org/10.1016/j.microc.2020.104698>.