

Effects of Recycled Concrete on Structural Behavior of Composite Beams with Y-Rib Shear Connectors

Mohammed N. Salman¹, Abdunnasser M. Abbas², Haleem K. Hussain³

¹Department of Civil Engineering, College of Engineering, University of Basrah, Basrah, Iraq

²Department of Civil Engineering, College of Engineering, University of Basrah, Basrah, Iraq

³Department of Civil Engineering, College of Engineering, University of Basrah, Basrah, Iraq

*Corresponding author E-mail: engpg.muhammad.noori@uobasrah.edu.iq

(Received 23 Aug, Revised 8 Sep, Accepted 10 Sep)

Abstract: This study inspects the structural behavior of composite steel concrete beams connected together by Y-Rib shear connectors using recycled concrete. The main method involves using stud shear connectors with normal concrete. By comparing the structural performance of Y-Rib shear connectors with conventional stud shear connectors, the study aims to determine the benefit of using this type of connector with recycled concrete. Improved results in terms of maximum load-bearing capacity before failure and maintaining structural integrity until failure would indicate a viable solution to the sliding issue seen in traditional composite beams. Regardless of challenges in acquiring traditional shear connectors, the study also explores an alternative: 20mm diameter reinforcing bars. Although this falls outside the primary research scope, the main focus remains on the behavior of composite beams connected by Y-shaped shear connectors with recycled concrete. The investigation encompasses 18 shear connector types, divided into two groups: 9 models with normal coarse aggregate concrete (35.17 MPa) and 9 models with recycled coarse aggregate concrete (33.48 MPa) to determine the benefit of recycled aggregate concrete usage.

Keywords: Composite Beam, Shear connector behavior, Concrete recycling, Recycled aggregates, Y-Rib shear connector design, Concrete replacement, Construction waste management, Recycled construction materials.

1. Introduction

The composite beam is a structure composed of two parts: the lower part is made of steel, while the upper part is made of concrete. These two parts are connected together to function as a single unit through shear connectors. Shear connectors are used to ensure the composite beam behaves as a unified piece. Generally, the Stud Shear is the prevailing type. In recent times, several types of shear connectors have been proposed. These connectors can be classified into two categories: ductile and rigid. Many researchers have studied both types of connectors by evaluating different properties such as shear resistance, ductility and structural behavior.

Kim et al. [1] conducted experiments and analyses on a composite girder equipped with stud shear connectors to assess variations in behavior relative to the level of shear connection. The test outcomes revealed minor disparities in the ultimate strength of the composite girder contingent upon the extent of shear connection. Papastergiou and Lebet [2] introduced a novel composite girder design featuring an inventive shear connection mechanism involving adhesion, interlocking, and friction. Experimental findings substantiated the composite girder's capacity to withstand fatigue loading effectively. Kim et al. [3,4] introduced a novel Y-type perfbond rib shear connector as an innovative variation of the perfbond rib shear connector. Push-out tests were executed to validate its shear resistance and ductility. The study investigated several design factors—concrete strength, quantity of transverse rebar, rib thickness, and Y-

shape angle—to assess their impact on the connector's performance. Based on the experimental outcomes, Kim et al. [3,4] proposed a shear resistance equation for the Y-type perfo-bond rib shear connector. Shan et al. [5] investigate the short-term behavior of glubam-concrete composite beams through both experimental and analytical investigations. A total of six full-scale composite beams were tested under four-point bending to evaluate their ultimate load-carrying capacity, deflection, crack pattern, and failure mode. The results showed that the ultimate load-carrying capacity of the composite beams increased with the increase in the shear connector density and the glubam section size. The analytical predictions were in good agreement with the experimental results. The study concluded that the use of glubam in composite construction can improve the structural performance and reduce the material cost of composite beams. The findings can inform the design and construction of sustainable and cost-effective composite structures. Lin [6] tested six full-scale composite beams, with three of them using recycled concrete and the other three using conventional concrete. The beams were tested under four-point bending to investigate their ultimate load-carrying capacity, deflection, crack distribution, and failure mode. The results showed that the ultimate load-carrying capacity of the beams with recycled concrete was slightly lower than that of the beams with conventional concrete. However, the difference was not significant, and the beams with recycled concrete exhibited similar behavior in terms of deflection and crack distribution compared to the beams with conventional concrete. Kim [7] discuss recycled concrete produced by crushing and reusing concrete waste, which can reduce the environmental impact of construction activities and conserve natural resources, and the use of recycled concrete in composite construction has the potential to reduce the carbon footprint of the construction industry and promote sustainability. In composite construction, the connection between the steel and concrete components plays a crucial role in determining the structural behavior of the composite beam. The traditional form of mechanical connection is the headed stud shear connector, which has been extensively studied in previous research. Wu et al. [8], tested six full-scale composite beams, with three using recycled concrete and the other three using conventional concrete. The beams were subjected to a three-point bending test to evaluate their flexural behavior, crack pattern, and failure mode. The results showed that the ultimate load-carrying capacity of the beams with recycled concrete was slightly lower than that of the beams with conventional concrete. However, the beams with recycled concrete exhibited similar behavior in terms of stiffness, deflection, and crack pattern compared to the beams with conventional concrete. In a study by Singh et al. [9], six full-scale composite beams were tested, with three using recycled concrete and the other three using conventional concrete. The beams were tested under four-point bending to investigate their ultimate load-carrying capacity, deflection, crack distribution, and failure mode. The results showed that the ultimate load-carrying capacity of the beams with recycled concrete was slightly lower than that of the beams with conventional concrete. However, the difference was not significant, and the beams with recycled concrete exhibited similar behavior in terms of deflection and crack distribution compared to the beams with conventional concrete. Sener et al. [10] argue selection Composite construction using steel and concrete widely used in the construction industry due to its high strength, stiffness, and durability. However, with increasing environmental concerns, and growing interest in using recycled materials in construction, including recycled concrete.

In this study, a test of the composite beam connected by Y-rib shear connector made with recycled concrete is conducted, and compare the results are compared with the structural behavior of a composite beam connected by a conventional stud shear connector. This test is performed to analyze the load-carrying capacity and maximum deflection in the mid-span and slide between the two steel and concrete parts, and therefore the knowledge of the structural behavior of the composite beam connected by Y-rib shear connectors with recycled concrete explains whether the use of this type is feasible or not. Moreover, the structural behavior of composite beam that are done using available materials on the work site (Reinforcement rebar) and know if its use will give the same results that can get it using conventional stud shear connectors, thus contributing to reducing the cost by using reinforcing steel waste and finding a quick solution available as a substitute for conventional stud shear connector that we have difficulty obtaining because they are not available in the markets, also this study aims to know if the using of a recycled concrete can be feasible and gives the same results.

2. Experimental Plan

The experimental works furnish comprehensive datasets and attributes concerning the materials, machinery, and instrumentation used for testing purposes. These investigations were conducted within the controlled environment of the Construction Materials Laboratory, situated within the Civil Engineering Department at the esteemed College of Engineering, University of Basra.

2.1 Materials

2.1.1 Cement

In this study, Falcon, an ordinary Portland cement of Iraqi origin, was employed as the fundamental binding material for fabricating all specimens. The physical attributes of the used cement are itemized in Table 1, while the chemical composition analysis outcomes are presented in Table 2. It is noteworthy that these results align harmoniously with the prescribed benchmarks articulated within the Standard Iraqi specification denoted as IQS N05 1984 [11], which pertains to the stipulated criteria for ordinary Portland cement.

Table 1. Physical Properties for Cement*.

Physical Property	Specific surface area (Fineness) (m ² /kg)	Setting time (hr:min) (Vicat apparatus)		Compressive Strength MPa	
		Initial	Final	3-day	7-day
Test results	321	2:10	4:50	18	26
IQS No. 5/1984	230 (Min)	00:45 (Min.)	10:00 (Max.)	15 (Min.)	23 (Min.)

* Construction materials laboratory of the College of Engineering, Basrah University

Table 2. Chemical analysis and main compounds of cement*.

Compound composition of Cement									
CaO	SiO ₂	Al ₂ O ₃	Fe ₂ O ₃	MgO	Na ₂ O	K ₂ O	SO ₃	I.R	LOI
62.82	20.24	6.28	3.51	4.55	0.21	0.62	2.11	0.57	0.73
Main Components of Cement									
C ₃ S		C ₂ S		C ₃ A		C ₄ AF			
40.73		27.92		11.18		10.29			

* Chemical tests lab. in the College of Eng. Basrah University

2.1.2 Aggregate

2.1.2.1 Fine Aggregate (Sand)

In this study, fine aggregate sourced from the Al-Zubair region of Basrah city was used consistently across all concrete mixtures. The fine aggregate possessed a maximum particle size of 4.75 mm with a fineness modulus measuring (2.92). The physical properties of this aggregate are depicted in Figure (1), while Table (3) enumerates the outcomes of the fine aggregate grading assessment. Notably, these characteristics adhered to the stipulations outlined within the Iraqi specification IQ. S No. 45/1984. [12].

2.1.2.2 Coarse Aggregate (Gravel)

Two types of coarse aggregate were used in this study, natural coarse aggregate NCA and recycled coarse aggregate RCA. The crushed gravel was used from JABAL SANAM in the south of Basrah Governorate was used as natural coarse aggregate with a max size of 19.5 mm. While RCA has been formed by recycled concrete crushing, graded within the accepted proportions according to the specifications. The grading and the physical properties of NCA

and RCA are shown in Fig. (2), Fig. (3) and Table (4), respectively, they satisfied the limits of Iraqi standard IQ. S No.45/1984 [9] requirements.

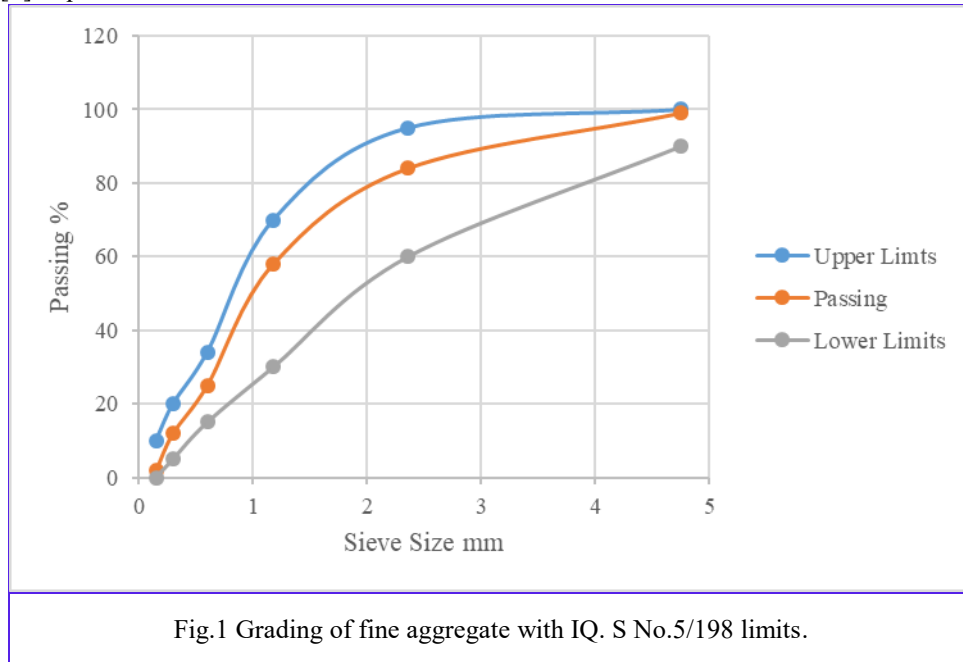

Table 3. Physical properties of fine aggregate.

Physical properties	Test result	Limits of IQ.S No.45/1984
Specific Gravity	2.64	-
Sulphate content	0.36	≤ 0.5
Absorption	1.07	-

2.1.3 Mix Water

Within the scope of this investigation, standard tap water of ordinary composition was employed throughout different stages of the concrete production process, encompassing mixture preparation, specimen casting, and the subsequent curing procedures. This included the treatment and maintenance of specimens in the form of cubes, cylinders, and other samples.

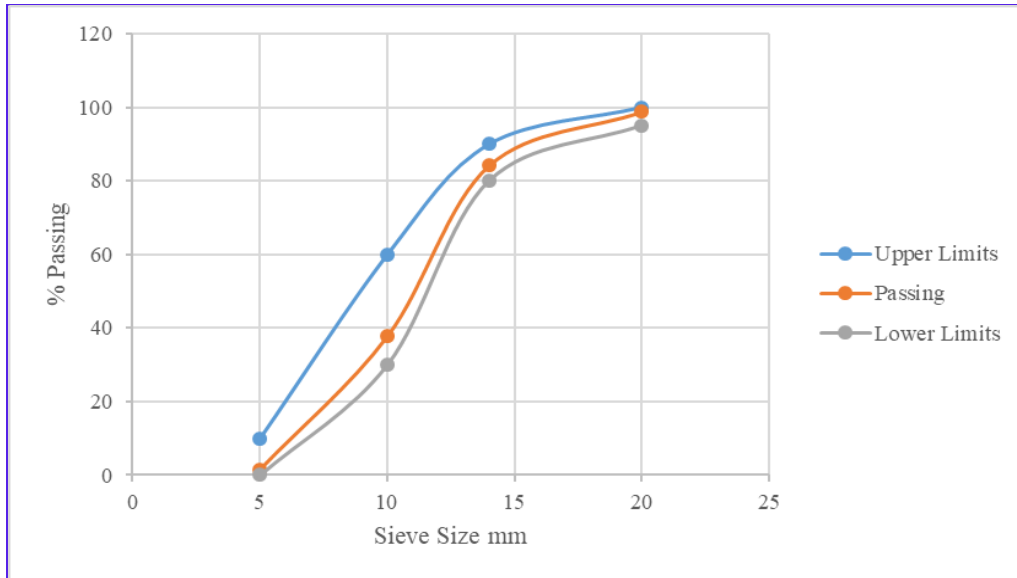

Fig.2 Grading of Natural coarse aggregate with IQ. S No.5/198 limits.

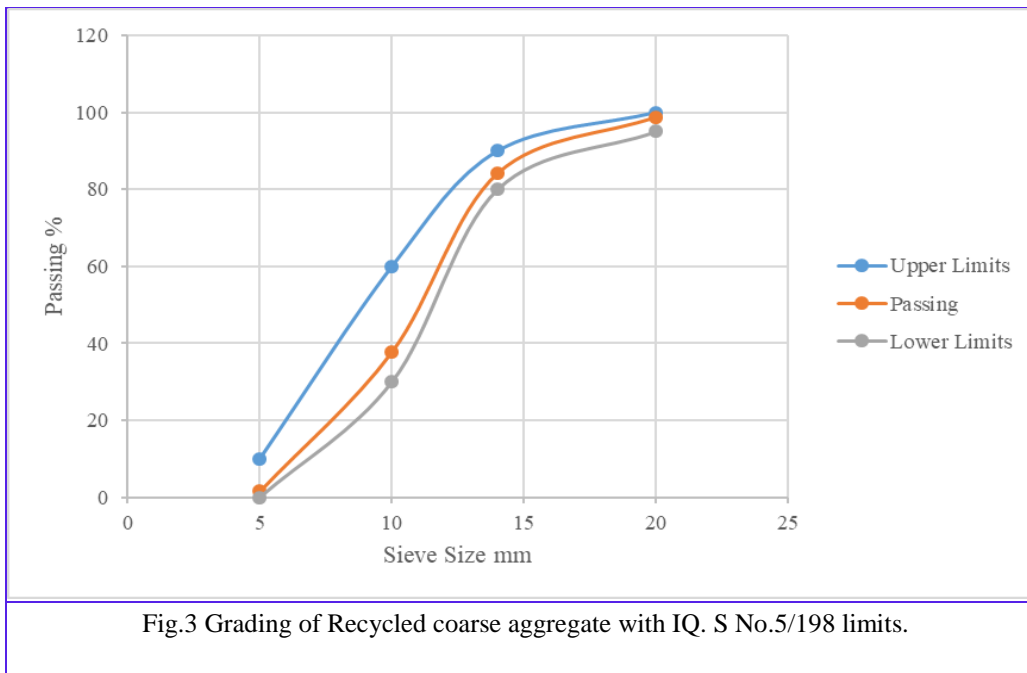

Fig.3 Grading of Recycled coarse aggregate with IQ. S No.5/198 limits.

Table 4. Physical properties of Coarse aggregate.

Physical properties	Test Result		IQ. S No. 45/1984
	NCA	RCA	
Specific gravity	2.63	2.39	-
Sulphate content SO3	0.079	0.089	≤ 0.1 %
Chloride content CI	0.092	0.016	≤ 0.1 %
Absorption	0.65	6.2	-

2.1.4 Superplasticizer

A powerful superplasticizer, Sika ViscoCrete-180 GS, shown in Fig. (4), was used in this research. It satisfied the ASTM C494 [13] requirements.

Table 5. properties of Sika ViscoCrete-180 GS data sheet.

Appearance and colour	Light brownish
Specific gravity	1.070 ± (0.02) g/cm ³
pH-Value	4 - 6
Recommended dosage	(0.5% - 2%) by weight of total cementitious materials
Uses	High Performance Concrete Flowing Concrete Durable Concrete Pumped Concrete

2.1.5 Stud Shear Connector

This type of connector is the most used type among the shear connectors, so it is considered a reference for compared to other shear connectors used in this research.

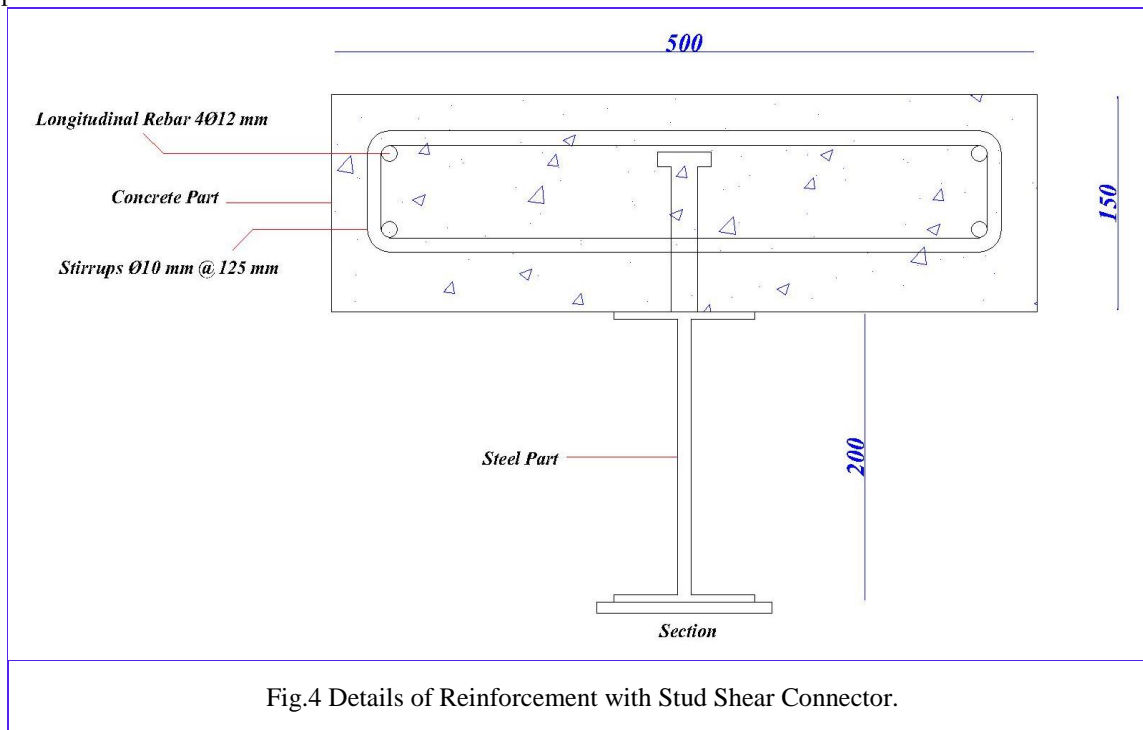

Fig.4 Details of Reinforcement with Stud Shear Connector.



2.1.6 Steel Reinforcement Rebar

Steel is a common material used in composite beam construction due to its high strength and stiffness, as well as its ability to be easily welded to other steel components. Steel rebar has been used in this work for composite beam design. A rebar with ($\text{Ø } 10 \text{ mm}$) diameter used as Y-rib, while ($\text{Ø } 20 \text{ mm}$) was used for Stud Shear as in Fig. (6). The shear reinforcement bar formed to give a Y-type shape as in Figure (7).

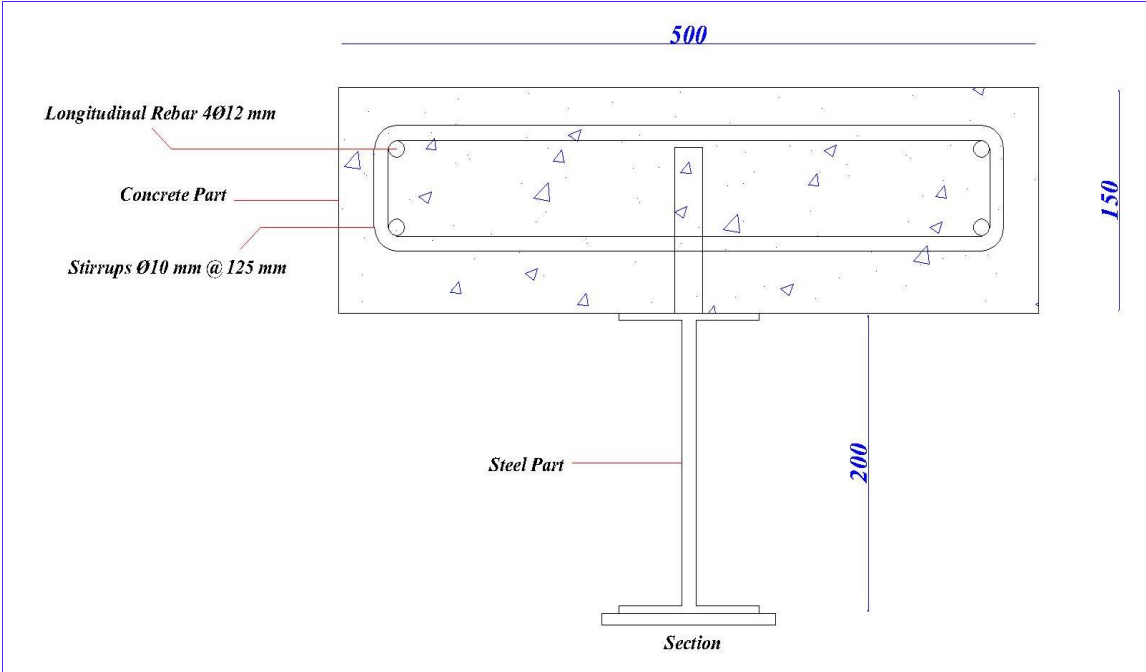

Fig. 6 Details of Reinforcement with Rebar Ø 20 mm (Stud Shear).



Fig.7 Rebar Ø 20 mm (Stud Shear).

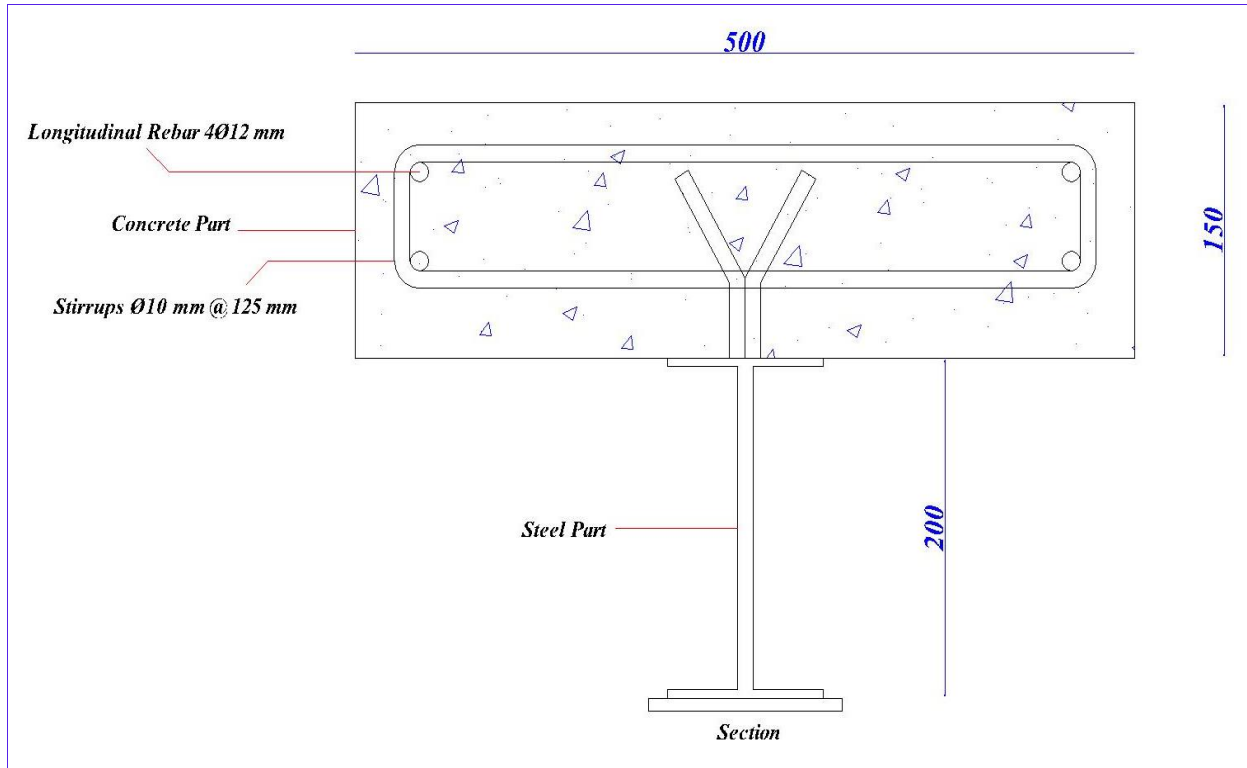

Fig.8 Details of Reinforcement with Rebar Ø 10 mm (Y-Rib).

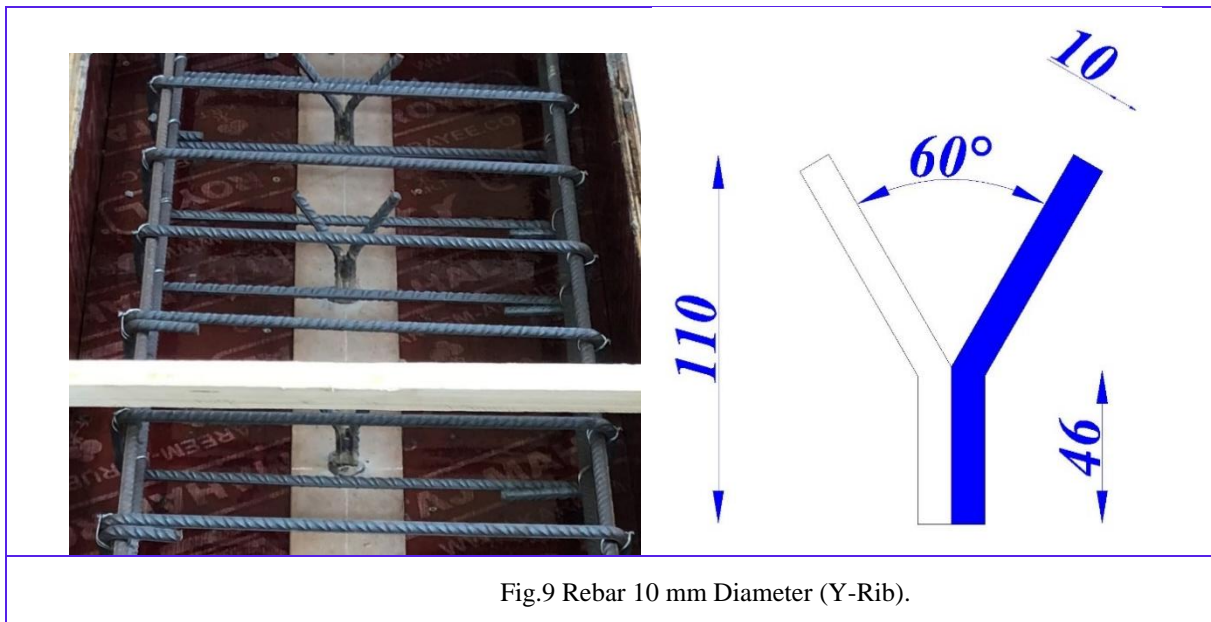

Fig.9 Rebar 10 mm Diameter (Y-Rib).

2.1.7 Y-rib smooth and Checker plates

Y-rib smooth and checker plates are types of shear connector welded to the top flange of the steel beam and

embedded into the concrete part as shown in figure (8). The Y-rib has a unique shape that helps to increase the bond strength between the steel beam and the concrete part, allowing them to act as a single structural unit.

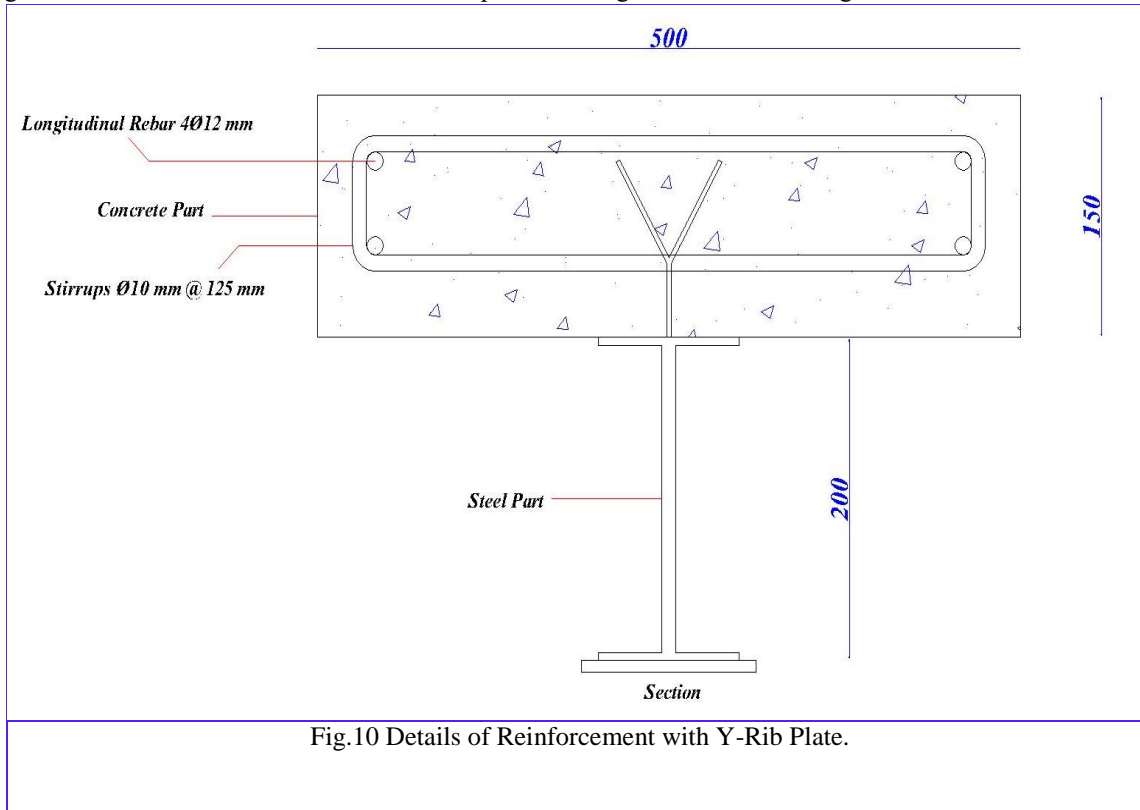

Fig.10 Details of Reinforcement with Y-Rib Plate.



Fig.11 Y-Rib (Checker Plate).



Fig.12 Y-Rib (Smooth Plate).

2.2 Concrete Mix Proportions

One mixing ratio was used for regular concrete, while in recycled concrete, the same mixing ratio was employed with a substitution of 30% of the aggregate with crushed cubes from old concrete, as outlined in table (5).

Table 6. Mix proportion of NC and RC.

Materials	Mix	
	NC	RC
Cement Kg.	400	400
W/C	0.35	0.35
Water Kg.	140	140
Sand Kg.	560	560
Gravel (Normal) Kg	960	672
Gravel (Recycled) Kg	-	288
S.P. Kg.	30	30

w/c: water cement ratio, S.P: Superplasticizer

2.3 Specimens preparation

2.3.1 Standard Molds

The molds adhering to established standards, characterized by dimensions of (150×150×150) mm for cubes and (300×150) mm for cylinders, were meticulously readied. These molds were meticulously lubricated with a suitable oiling agent in preparation for the casting of the specimens, as visually depicted in Figure (11).



Fig.13 standard molds.

2.3.2 Mixing Procedures

The process of mixing was executed within the confines of a rotary tilting drum-type mixer, possessing a volumetric capacity of 0.35 cubic meters. The mixing procedure was according to BS 1881-125:2013[14].

2.3.3 Casting and curing

Before commencing the mixing procedure, meticulous preparations were undertaken. Standard molds were carefully readied and cleansed, with their internal surfaces being lubricated to ensure a smooth casting process. Once the molds were appropriately set, the mixing process was initiated. The mixture was filled into the molds in a stratified manner, consisting of three layers, with each layer compacted using a vibrating rod. Following the layering process, the upper surface of the concrete specimens was leveled and smoothed using a hand shovel, as depicted in Figure (12).

Upon the lapse of twenty-four hours post-casting, the cylinders, prisms, and cubes were gently extracted from their molds. Subsequently, these samples were transferred to a water tank within the laboratory environment, where they underwent a curing period of 28 days. Throughout this curing process, the specimens were regularly moistened, covered with damp cloths, and this regimen was repeated daily over the course of three days. This comprehensive treatment protocol was instituted to prime the samples for subsequent testing.



a. Compaction by rod vibration.



b. leveling and marking the cubes and cylinders.



c. Cylinder and cubes extracted from their molds.



d. Curing of the samples

Fig.14 Casting and curing of the standard molds and samples.

2.4 Normal Concrete and Recycled Concrete Hardened Tests

To assess the mechanical characteristics of each concrete mixture, six cubes and three cylinders were fabricated to determine the mean compressive strength (f_{cu}) at both 7 and 28 days, according to BS EN 12390-1:2021 [15] and ASTM C39M [16], three cylinders to obtain the average elastic modulus according to ASTM C469[17]. Figure (13) illustrates the procedures employed for molding and conducting the tests.



3. Results and Discussions

According to the completion of tests on all specimens, it became evident that the proposed shear connectors consistently outperformed the conventional stud shear connector. This superiority can be attributed to the strong interaction between the connectors and the concrete, indicating the potential for alternative solutions to the conventional stud shear connector. Notably, the Y-rib shear connector exhibited the most favorable outcomes due to its robust interlocking within the concrete mass from both sides.

Furthermore, the welding along the length and sides of the shear connector enhanced its strength and distinctiveness. This reinforcement contributed to the composite beam's sustained structural integrity, maintaining its unified behavior until failure. This approach offers a prototypical solution to address the issue of sliding interaction between the concrete and steel components. In contrast to composite beam linked with conventional stud shear connectors, where the concrete and steel parts tend to separate, the use of the Y-rib shear connector ensured the beam functions as a single unit.

This deduction is corroborated by the results observed in the models using reinforcement-based shear connectors. Despite the impressive load-bearing capacity, traditional shear connectors did not prevent the disjunction between the concrete and steel elements. In contrast, the Y-rib shear connector maintained its composite behavior, underscoring its effectiveness in addressing the sliding interaction between concrete and steel components.

3.1 Test Procedure

After 28 days from the casting of the specimens, the testing site is cleared and restricted to authorized personnel only during testing. The specimens are prepared for testing by affixing specific labels denoting the type of concrete used in casting the concrete component and the shear connector employed. The testing process involves lifting the specimen using specialized equipment and placing it on a designated rail before introducing it into the testing apparatus.

Ensuring that the 200 cm long specimen is centered within the span is crucial, with the distance between supports measuring 180 cm, leaving 10 cm on each side. The midpoint on both sides of the specimen's upper surface

is marked to ensure that the point load will be applied at the center. A load cell is positioned at this midpoint to sense the applied load. The load cell's role is to measure the load imparted.

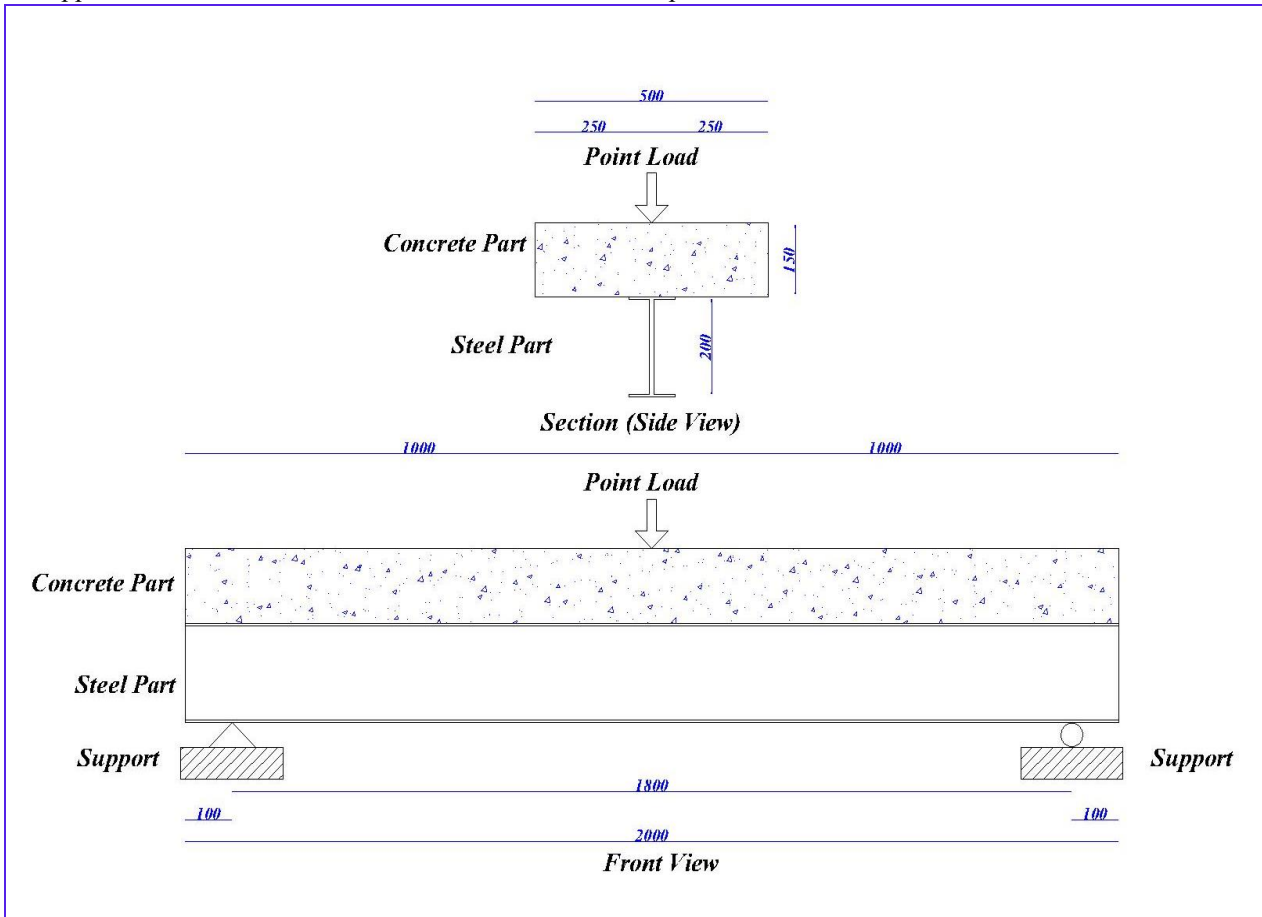

Fig.16 Details of Beam Testing.

Additionally, sensors are attached to monitor deflection at the midpoint under point load as well as the sliding interaction between the concrete and steel components. The readings from these sensors, as well as the load cell, are transmitted to a computer system, which records all data through dedicated software.

After verifying the functionality of all sensors and ensuring the proper setup of the testing parameters in the software, the load application begins incrementally. Continuous monitoring of the specimen takes place, recording the load at the onset of the initial cracking, followed by gradual load increments until the specimen reaches the point of failure. After collecting all readings, the sensors are detached, and the load is removed from the specimen.

The type of failure that occurs in the specimen is then examined, and the specimen is extracted using the same equipment and process used for insertion. This procedure is repeated for all specimens following the same methodology.



Fig.17 Beam test machine.



Fig.18 Beam Testing.



Fig.19 Load Cell under the load.



Fig.20 deflection gage sensor.



Fig.21 slip gage sensor.

3.2 Test Results

The main aim of the current study is to evaluate the structural behavior of composite beam connected by Y-Rib shear connector with recycled concrete including experimental and numerical results and comparison between them. Various properties of tested samples, such as the type of concrete used and the type of shear connector. The entire samples have identical dimensions and are loaded until the failure is reached. In addition, the interpretation of the effect of the type of concrete and the type of the shear connector on the strength, deflection and slipping between the concrete section and the steel beam of the composite beam, and the load deflection curves are presented, with the aim of reaching to see if the use of this type is feasible as a substitute for the conventional stud shear connector or not, the study of models that have been manufactured from materials available at the work site, whether it is an alternative to the conventional stud shear connector or as a type of shear connectors, aims to see whether their use is feasible or not.

3.2.1 Experimental Results

3.2.1.1 The experimental result for Ultimate Load and Maximum Deflection

The experimental values of load capacity, deflection and slip for the tested beams are listed in Table (7). In this table, a comparison was made for the load capacity between the control specimen and other specimens in each group. In general, the beams connected by Y-Rib shear connectors showed the ability of the final load higher than that connected by conventional stud shear connectors. Also the samples with a recycled concrete (within the percentage

used in that study) gave the results close of that resulting from the use of normal concrete. The maximum deflection was greater in samples manufactured by Y-Rib shear connectors, also the slip between the concrete and the steel was greater with the samples connected by Y-Rib shear connector, and most importantly, it continued to work as one unit until the stage of failure in which the failure was the collapse of the concrete part, unlike the conventional stud shear connectors that the concrete and the steel parts were separated from each other before the concrete part reached the collapse.

Table 7. Ultimate load capacity and maximum deflection.

Specimens Item	Ultimate load (KN)	Increase in ultimate load %	Deflection (mm)	Slip (mm)	Mode of failure
Stud NC	37.28	-	12.12	1.49	Slip
R20mm NC	42.48	14%	13.61	1.68	Slip
Y-R10mm NC	43.16	16%	13.81	1.69	Slip
Y-C.P. NC	46.70	25%	47.31	3.78	Collapse
P.I. 60% Y-C.P. NC.	38.38	3%	39.67	3.15	Collapse
P.I. 70% Y-C.P. NC	40.18	8%	40.69	3.25	Collapse
Y-S.P. NC	44.15	18%	45.01	3.59	Collapse
P.I. 60% Y-S.P. NC	35.46	-5%	36.73	2.93	Collapse
P.I. 70% Y-S.P. NC	37.24	0%	37.85	3.05	Collapse
Stud RC	35.67	-	10.33	1.27	Slip
R20mm RC	40.22	13%	12.15	1.49	Slip
Y-R10mm RC	42.30	19%	12.45	1.53	Slip
Y-C.P. RC	44.15	24%	36.41	2.95	Collapse
P.I. 60% Y-C.P. RC	35.76	0%	29.84	2.37	Collapse
P.I. 70% Y-C.P. RC	37.70	6%	30.47	2.49	Collapse
Y-S.P. RC	42.87	20%	35.01	2.81	Collapse
P.I. 60% Y-S.P. RC	34.30	-4%	27.93	2.32	Collapse
P.I. 70% Y-S.P. RC	36.01	1%	28.99	2.42	Collapse

3.2.1.2 Effect of Shear Connector on Ultimate Load.

Shear connectors play a crucial role in the behavior of composite beams, where the primary purpose of shear connectors is to transfer shear forces and ensure composite action between the concrete part and the steel beam, which enhances the load-carrying capacity and overall performance of the composite beam. Different types of shear connectors can have varying effects on the ultimate load of a composite beam, the effect of shear connector types on the ultimate load of a composite beam depends on various factors, including connector geometry, material properties, bond strength between concrete and steel, and the overall structural design. Proper selection and design of shear connectors are essential to ensure optimal composite behavior and load-carrying capacity in composite beams. Engineering analyses and testing are typically conducted to determine the most suitable shear connector type for a specific project and loading conditions. The results obtained show the effect of the use of different types of shear connectors compared to the conventional connector, which shows the increase in ultimate load capacity, deflection and slipping compared to the conventional method by using stud shear connector.

The results obtained showed that the use of Y-Rib shear connector gives higher resistance than those obtained using the conventional stud shear connector, as well as for deflection and slipping, and the failure pattern of manufactured samples using these shear connector makes it the best, where the samples remained It works as one part until reaching the stage of failure, Regarding the resistance of the maximum load, there was an increase in the ability of the manufactured samples using Y-Rib checker plate by 25% with normal concrete and 24% with recycled concrete, manufactured using Y-Rib smooth plate by 18% with normal concrete and 20% with recycled concrete compared to the manufactured samples using the conventional stud shear connector, also regarding the deflection there was an increase in the deflection in the manufactured samples using Y-Rib checker plate by 290% with normal concrete and 252% with recycled concrete, manufactured using Y-Rib smooth plate of 271% with normal concrete and 239% with recycled concrete compared to the manufactured samples using the conventional stud shear connector, the same regarding the slip there was an increase in the slip in the manufactured samples using Y-Rib checker plate by 154% with normal concrete and 132% with recycled concrete, manufactured using Y-Rib smooth plate of 141% with normal concrete and 122% with recycled concrete compared to the manufactured samples using the conventional stud shear connector.

Also the results indicated that there is a feasibility of using the materials available at the work site of the remains of the reinforcing bars through their use or formation in various forms such as shear connectors, as it showed that the use of the shear connector made of the reinforcing bars with $\text{Ø}10$ mm through its formation in the form of a Y-shape gives higher results than that resulting from the use of a conventional stud shear connector, Regarding the resistance of the maximum load, there was an increase in the ability of the manufactured samples using Y-Rib $\text{Ø}10$ mm shear connector by 16% with normal concrete and 19% with recycled concrete compared to the manufactured samples using the conventional stud shear connector, also regarding the deflection there was an increase in the deflection in the manufactured samples using Y-Rib $\text{Ø}10$ mm shear connector by 14% compared to the manufactured samples using the conventional stud shear connector, the same regarding the slip there was an increase in the slip in the manufactured samples using Y-Rib $\text{Ø}10$ mm shear connector by 20% compared to the manufactured samples using the conventional stud shear connector, This makes its use a solution between the conventional stud shear connector and Y-rib shear connector, as it gives maximum load capacity higher than the conventional and closer to that resulting from the use of Y-rib shear connector, although it is related to deflection and slipping close to the conventional stud shear connector, This is as a result of following the same mechanics used in the conventional method, which is the reason that makes the failure pattern similar to the pattern of failure in the conventional method by separating the concrete and steel parts from each other through slipping.

The same thing is showed by the use of the reinforcing bar $\text{Ø} 20$ mm, as an alternative to the conventional stud shear connector, which is often not available in the local markets that gave higher results than that resulting from the use of a conventional stud shear connector, Regarding the resistance of the maximum load, there was an increase in the ability of the manufactured samples using bar $\text{Ø} 20$ mm shear connector by 14% with normal concrete and 13% with recycled concrete compared to the manufactured samples using the conventional stud shear connector, also

regarding the deflection there was an increase in the deflection in the manufactured samples using Y-Rib Ø10 mm shear connector by 14% compared to the manufactured samples using the conventional stud shear connector, the same regarding the slip there was an increase in the slip in the manufactured samples using Y-Rib Ø10 mm shear connector by 20% compared to the manufactured samples using the conventional stud shear connector.

3.2.1.3 Effect of Recycled Concrete on Ultimate Load.

The use of recycled concrete in composite beams can have both positive and negative effects on the ultimate load capacity, depending on various factors and how it is incorporated into the structure, the effect of recycled concrete on the ultimate load of a composite beam depends on various factors, including the quality and strength of the recycled concrete, proper mix design and proportioning, bond strength, and the specific application. When used correctly and under suitable conditions, recycled concrete can be a viable and sustainable option for composite beams without compromising load-carrying capacity. However, careful consideration, testing, and engineering expertise are essential to ensure structural integrity and performance. The results obtained appear the effect of the use of recycled concrete compared to the normal concrete, which shows a convergence in the ability to maximum load capacity, deflection and slip (within the studied ratio) compared to the normal concrete.

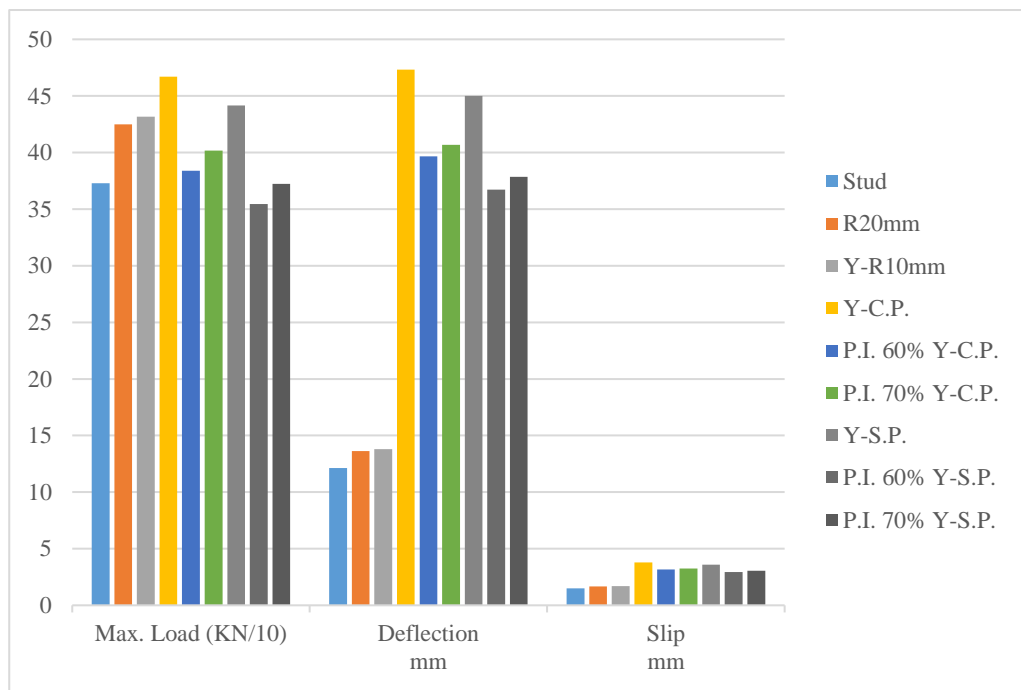

Fig.22 The Effect of Shear Connector Type with NC.

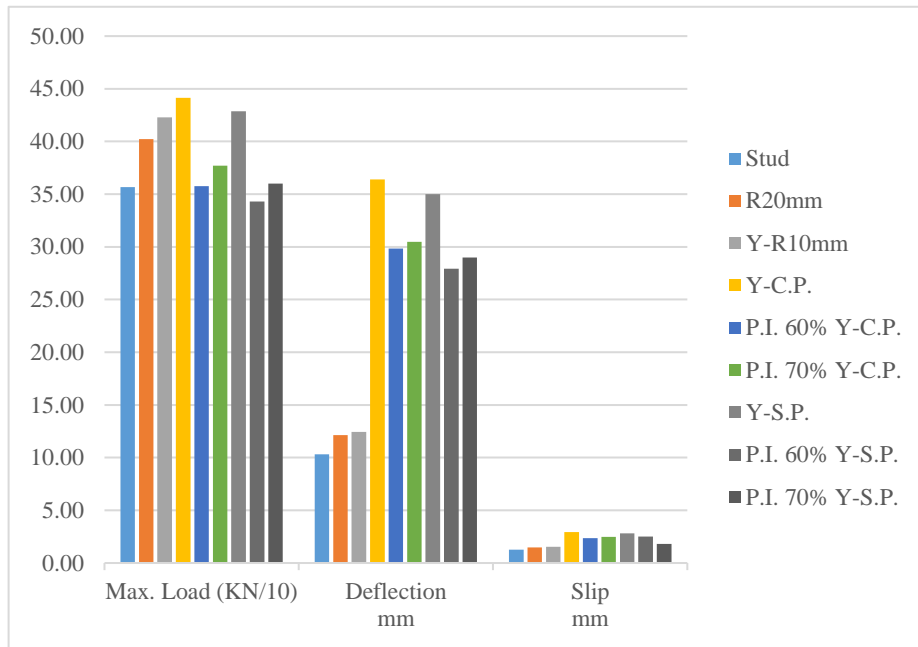

Fig.23 The Effect of Shear Connector Type with RC.

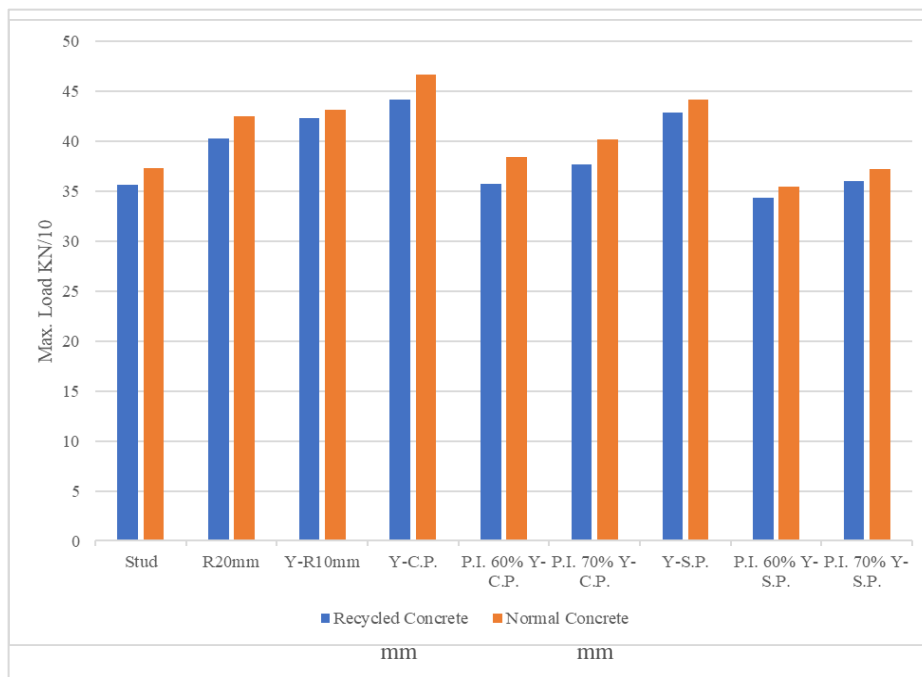

Fig.24 Comparison between NC and RC Effect on the Max. Load.

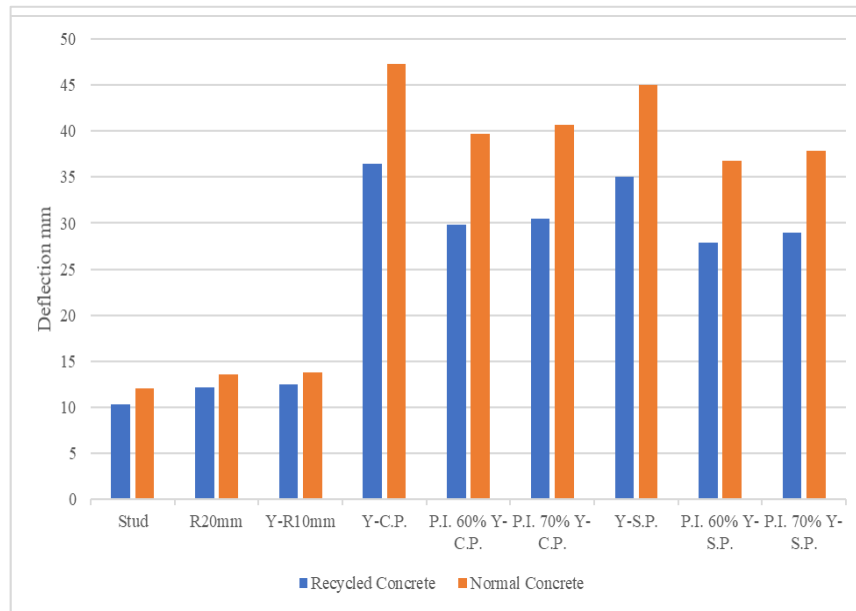

Fig.25 Comparison between NC and RC Effect on the Deflection.

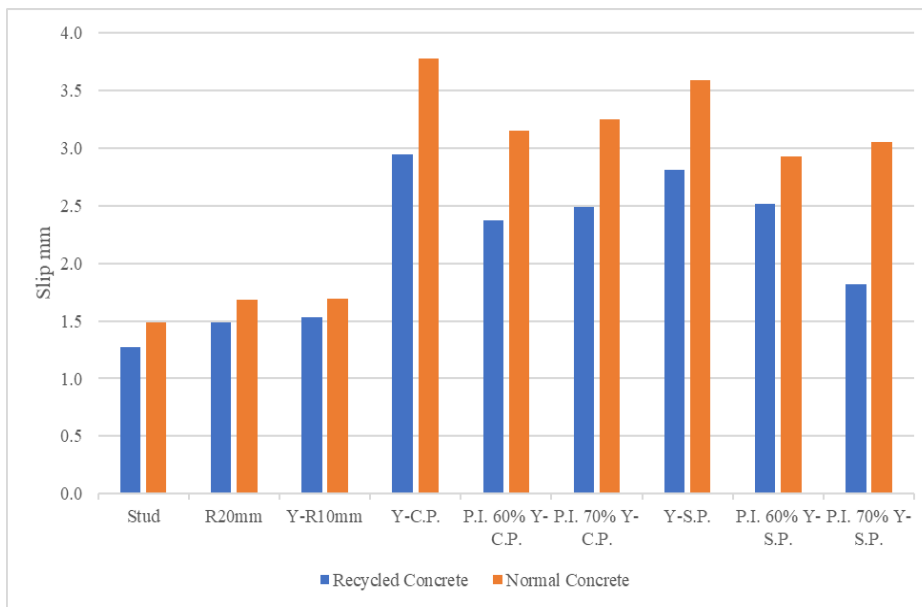

Fig.26 Comparison between NC and RC Effect on the Slip.

3.2.2 Numerical Results

The software Abaqus/CAE 2020 is used to conduct numerical analyses, involving the determination of ultimate loads, deflection, and slip, alongside assessing the response under various mesh sizes and different types of concrete. In order to validate and ensure the accuracy of these numerical methods, a comparison was conducted between the numerical outcomes and experimental results, using ultimate load values and load-deflection curves.

3.2.2.1 Ultimate Load and Maximum Deflection

Table (8) shows the ultimate loads and deflections of composite beams with different concrete types and shear connectors. The results of the laboratory test varied from those of the program test; however, that difference can be considered acceptable. Where the greatest percentage difference between a program's final load and a laboratory investigation's final load was 8%, the greatest percentage difference between a program's deflection and a laboratory investigation's deflection was 9.6 %, while the greatest percentage difference between a program's slip and a laboratory investigation's slip was 9.51%. Via using this table, it is possible to compare the specimens belonging to the same group. The composite beams with Y-Rib shear connector gave better results than the specimen with conventional stud shear connector. From the experimental and numerical outcome, the control specimens were shown to be the weakest among the other specimens. Following is the sequence of samples according to higher ultimate load, firstly the specimens with Y-Rib plates (checker and smooth plates), followed by specimens with Y-Rib 100 mm bar, then specimens with Rebar 20 mm, and finally specimens with conventional stud shear connector. Based on those results, a good impression can be formed about Y-Rib shear connector. As for partial interaction, which gave good proportions compared to the results that the fully interacting specimens gave.

Table 8. Ultimate load capacity and maximum deflection.

Specimens Item	Ultimate load (KN)		The difference in ultimate load %	Deflection (mm)		The difference in Deflection %	Slip (mm)		The difference in Slip %
	Exp.	Num.		Exp.	Num.		Exp.	Num.	
Stud NC	37.28	34.33	7.90%	12.12	11.40	5.95%	1.49	1.44	3.06%
R20mm NC	42.48	39.63	6.70%	13.61	12.93	5.06%	1.68	1.63	2.98%
Y-R10mm NC	43.16	40.88	5.30%	13.81	13.19	4.48%	1.69	1.66	2.16%
Y-C.P. NC	46.70	50.20	7.50%	47.31	42.91	9.30%	3.78	3.77	0.16%
P.I. 60% Y-C.P. NC.	38.38	39.42	2.70%	39.67	36.22	8.70%	3.15	3.08	2.20%
P.I. 70% Y-C.P. NC	40.18	41.87	4.20%	40.69	37.47	7.91%	3.25	2.97	8.56%
Y-S.P. NC	44.15	47.06	6.60%	45.01	41.31	8.21%	3.59	3.59	0.15%
P.I. 60% Y-S.P. NC	35.46	36.41	2.70%	36.73	33.20	9.60%	2.93	2.70	8.03%
P.I. 70% Y-S.P. NC	37.24	39.40	5.80%	37.85	34.26	9.50%	3.05	2.76	9.40%
Stud RC	35.67	32.89	7.80%	10.33	9.34	9.60%	1.27	1.19	6.07%

R20mm RC	40.22	37.16	7.60%	12.15	11.56	4.81%	1.49	1.42	4.78%
Y-R10mm RC	42.30	40.23	4.90%	12.45	11.75	5.62%	1.53	1.48	3.27%
Y-C.P. RC	44.15	47.68	8.00%	36.41	35.75	1.80%	2.95	2.84	3.64%
P.I. 60% Y-C.P. RC	35.76	37.94	6.10%	29.84	28.62	4.10%	2.37	2.31	2.30%
P.I. 70% Y-C.P. RC	37.70	40.64	7.80%	30.47	29.00	4.82%	2.49	2.40	3.67%
Y-S.P. RC	42.87	44.71	4.30%	35.01	34.51	1.41%	2.81	2.78	1.20%
P.I. 60% Y-S.P. RC	34.30	35.29	2.90%	27.93	25.76	7.80%	2.52	2.10	9.51%
P.I. 70% Y-S.P. RC	36.01	37.70	4.70%	28.99	26.30	9.30%	1.82	2.21	8.54%

3.2.2.2 Effect of Shear Connector on Ultimate Load in Abaqus

In Abaqus, shear connectors play a crucial role in simulating the behavior of composite beams accurately. Shear connectors are typically used to model the connection between the steel or concrete beam and the concrete slab or metal deck in a composite beam structure. These connectors are essential because they transmit shear forces and moments between the two materials, ensuring they behave as a cohesive unit under various loading conditions. The presence of properly defined shear connectors in an Abaqus simulation helps replicate the composite action seen in real-world structures, allowing for an accurate representation of load distribution, load-carrying capacity, and deflection characteristics. By specifying the appropriate properties and parameters for shear connectors, engineers can effectively capture the behavior of the composite beam and obtain reliable results that reflect the structural response and performance of such composite systems under different loading scenarios. This modeling approach aids in optimizing the design and analysis of composite beams, ensuring they meet safety and performance criteria.

5.3.3 Effect of Type of Concrete on Ultimate Load in Abaqus

The concrete type, whether normal or recycled, can significantly impact a composite beam's behavior in Abaqus. Normal concrete has well-documented mechanical properties and offers predictable and reliable performance in composite beams. In contrast, recycled concrete introduces variability due to uncertain material characteristics, potentially affecting load capacity, stiffness, and durability. Modeling a composite beam with recycled concrete in Abaqus requires careful consideration of material variations, accurate property definitions, and modeling of bond strength with the steel or concrete beam. In summary, while normal concrete yields consistent results, recycled concrete demands thorough material characterization and precise modeling to capture its potential variability accurately.

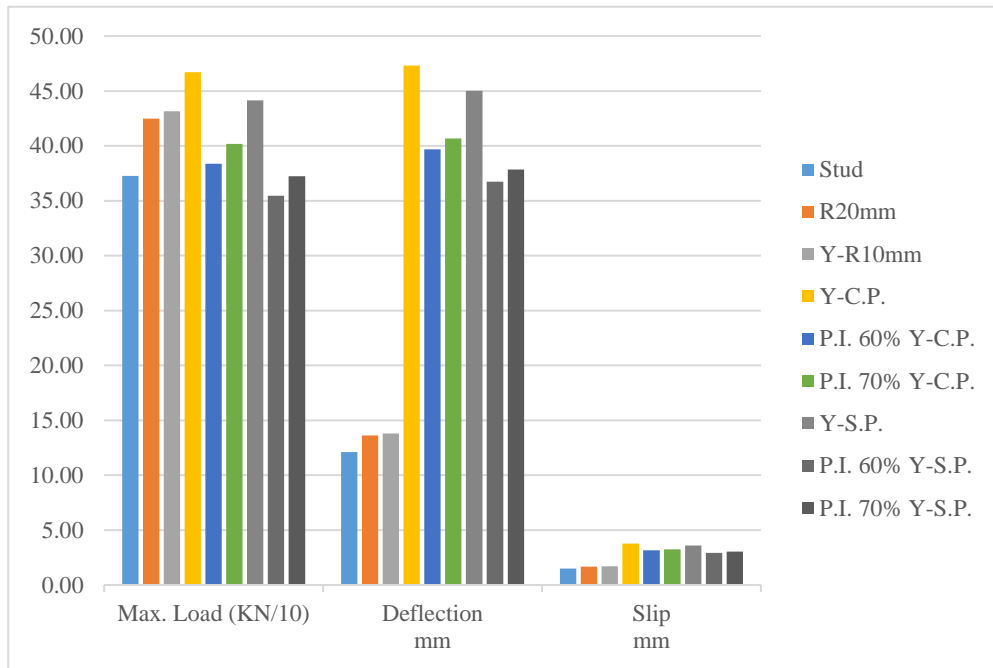

Fig.27 The Effect of Shear Connector Type with NC.

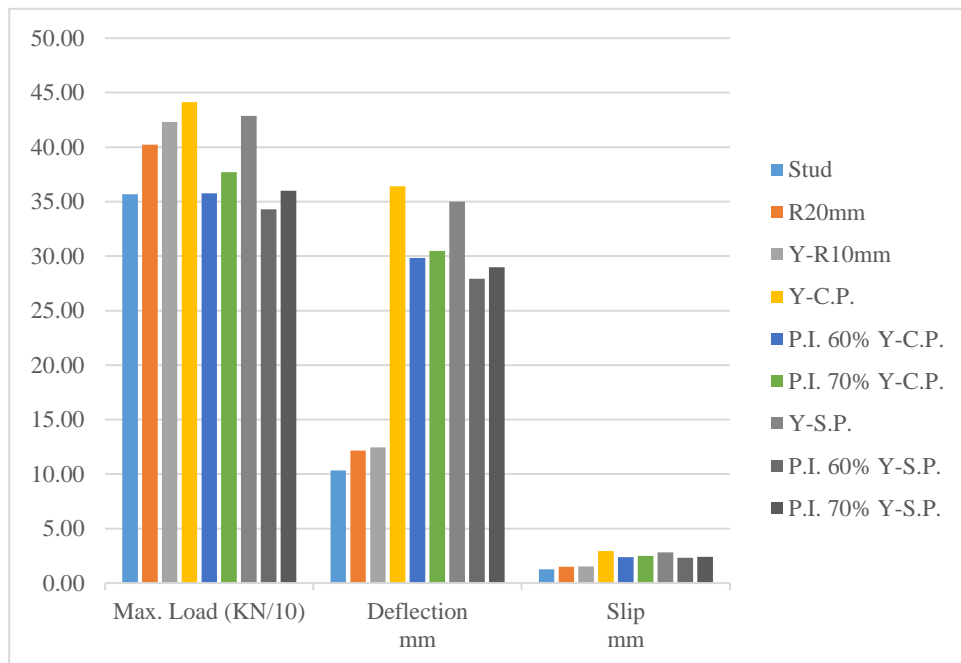

Fig.28 The Effect of Shear Connector Type with RC.

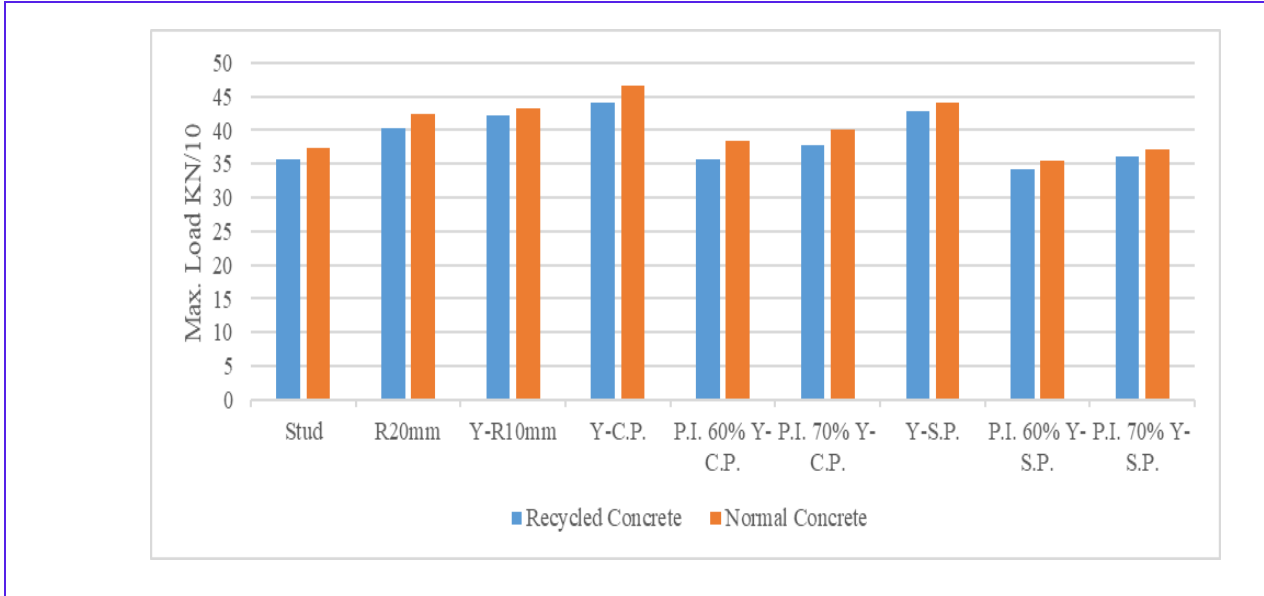

Fig.29 Comparison between NC and RC Effect on the Max. Load.

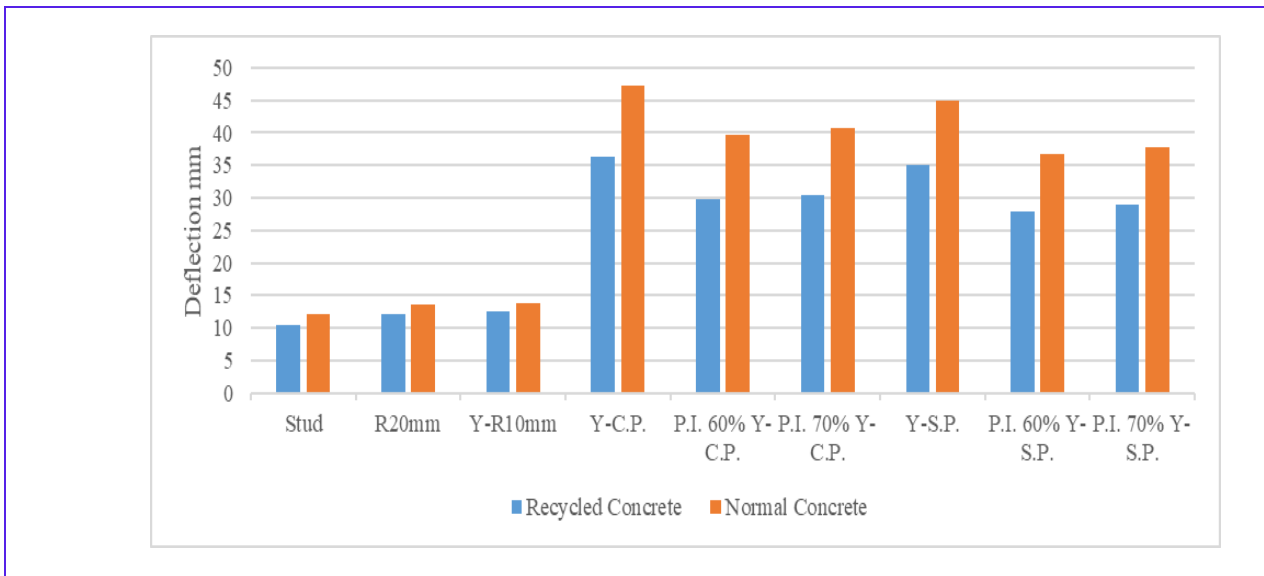

Fig.30 Comparison between NC and RC Effect on the Deflection.

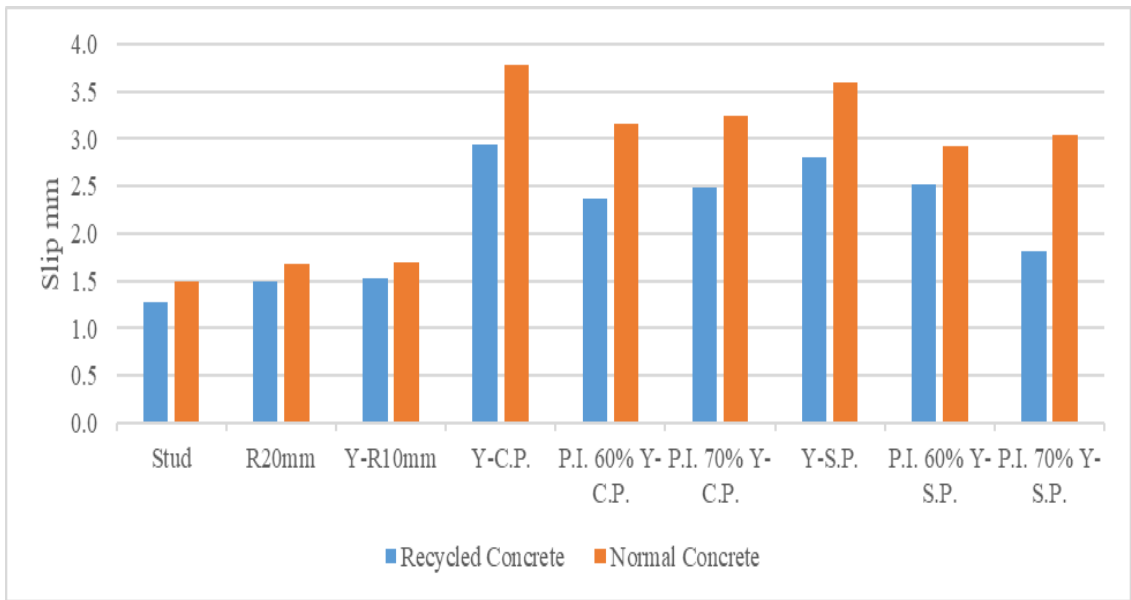

Fig.31 Comparison between NC and RC Effect on the Slip.

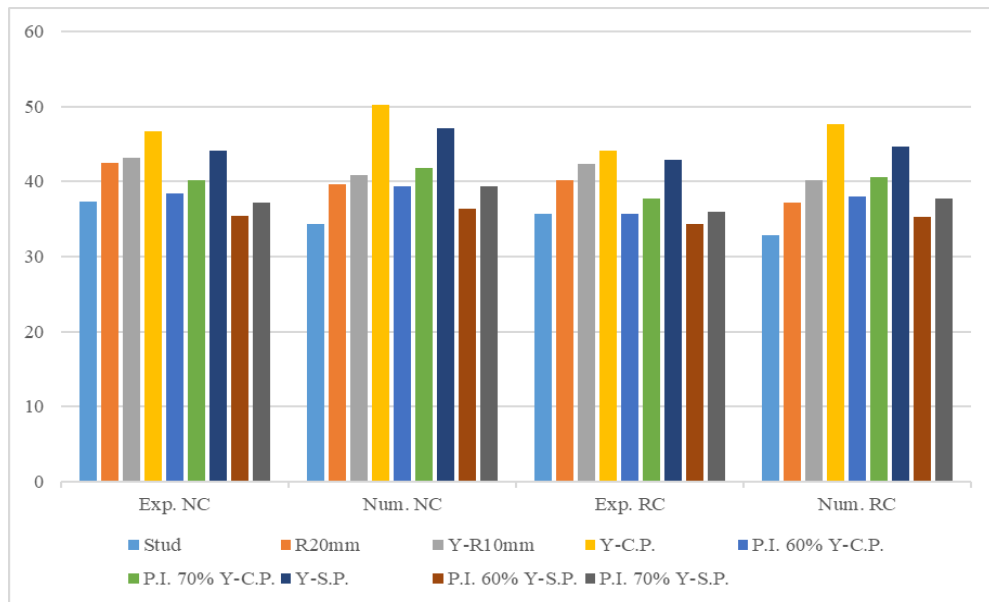

Fig.32 Comparison between Exp. and Num. Results on the Max. Load.

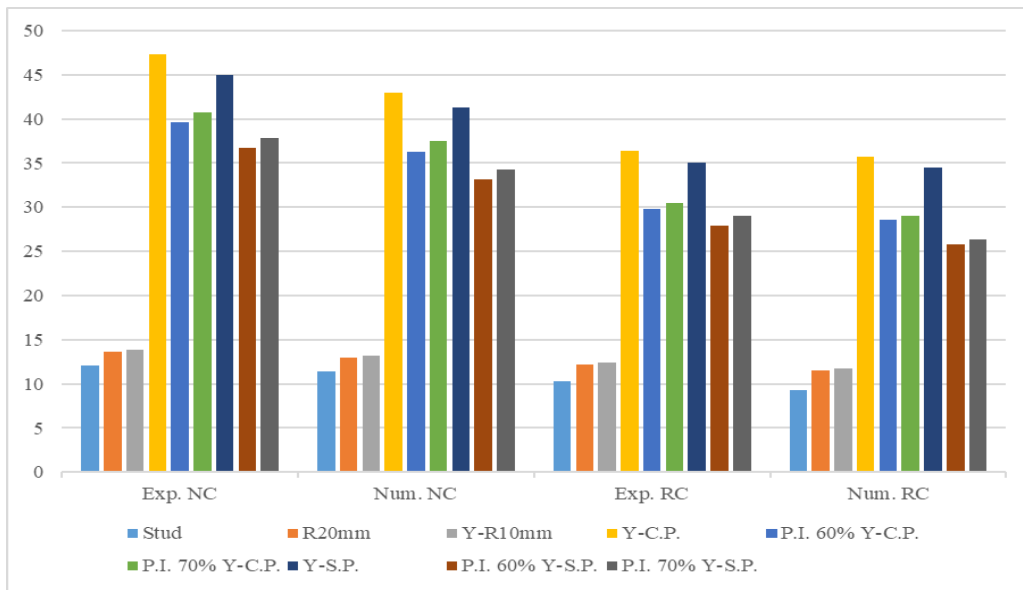

Fig.33 Comparison between Exp. and Num. Results on the Deflection.

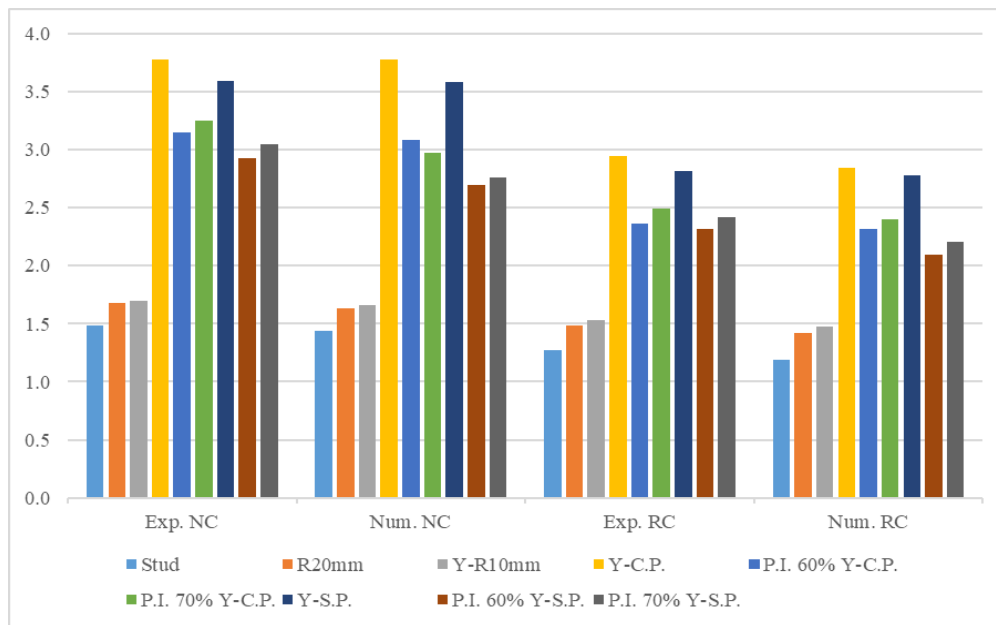

Fig.33 Comparison between Exp. and Num. Results on the Slip.

3.3 Load Deflection Curve

In the experimental study, a digital dial gauge was used to measure the deflections resulting from increased

loads applied to the bottom face of the concrete section of the specimens. Additionally, it was used to measure the slip occurring along the side edge between the concrete and steel parts. The Abaqus program was used to replicate these measurements, capturing both deflection and slip at the same positions as in the experimental work. Figure (35) illustrates the comparison between the results obtained from the experimental and numerical analyses. Generally, there is a satisfactory agreement between the two sets of results, albeit with a slight deviation observed in the experimental curve due to less-than-ideal conditions in the experimental environment as compared to the controlled software environment.

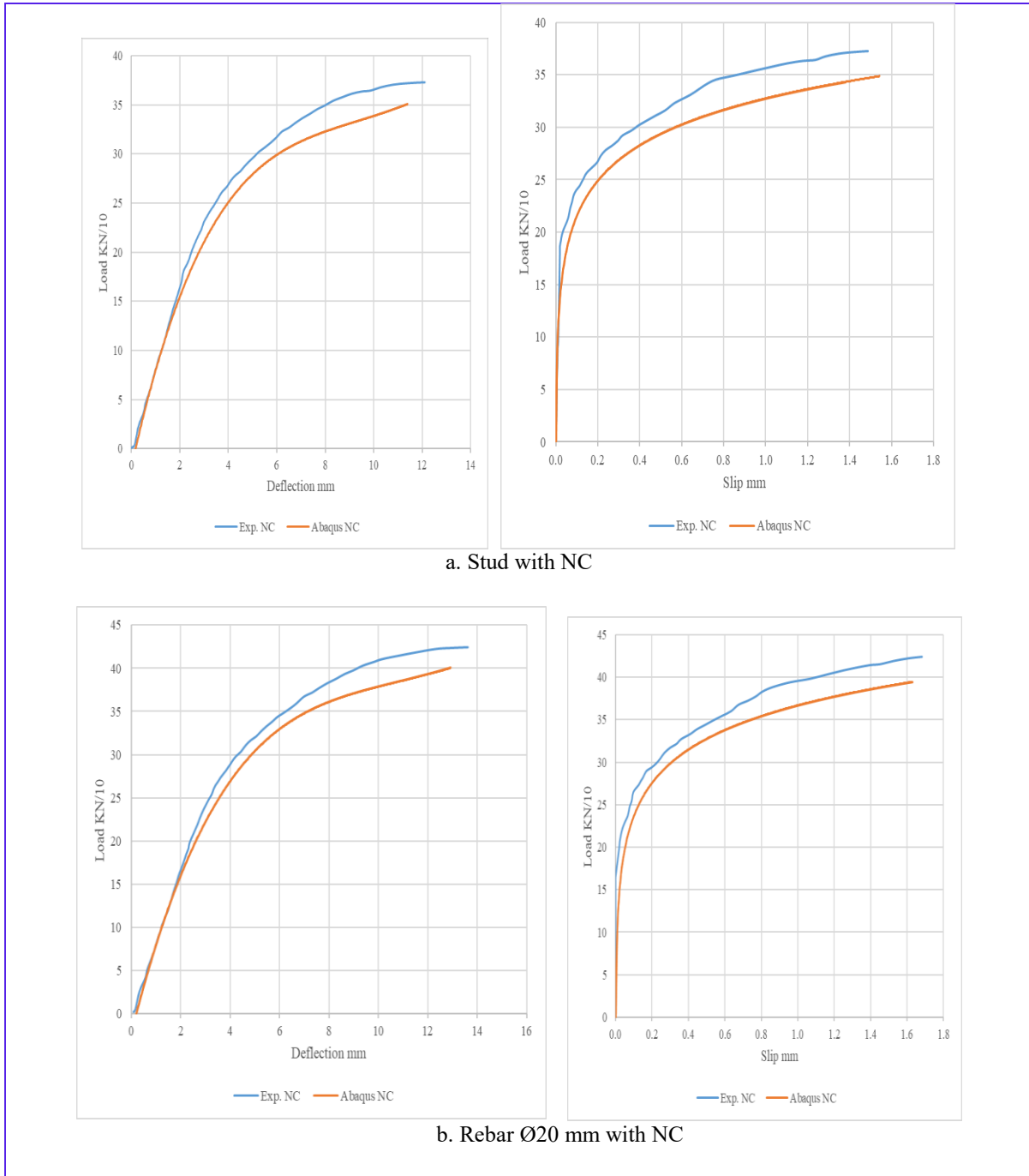
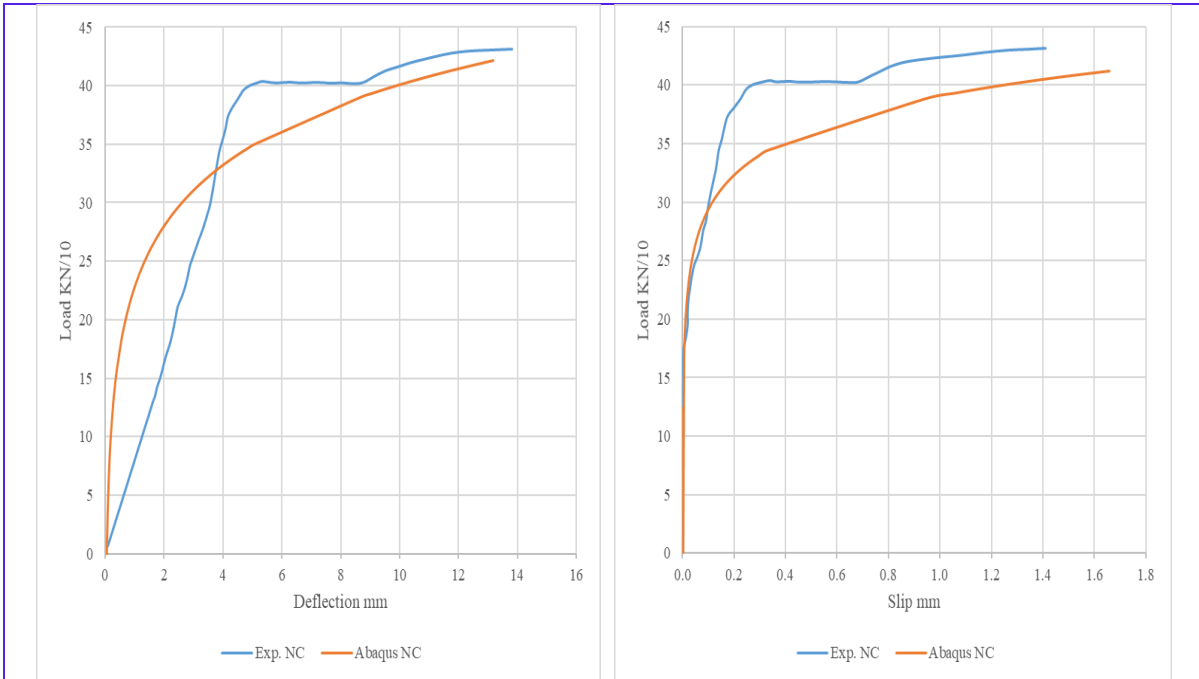
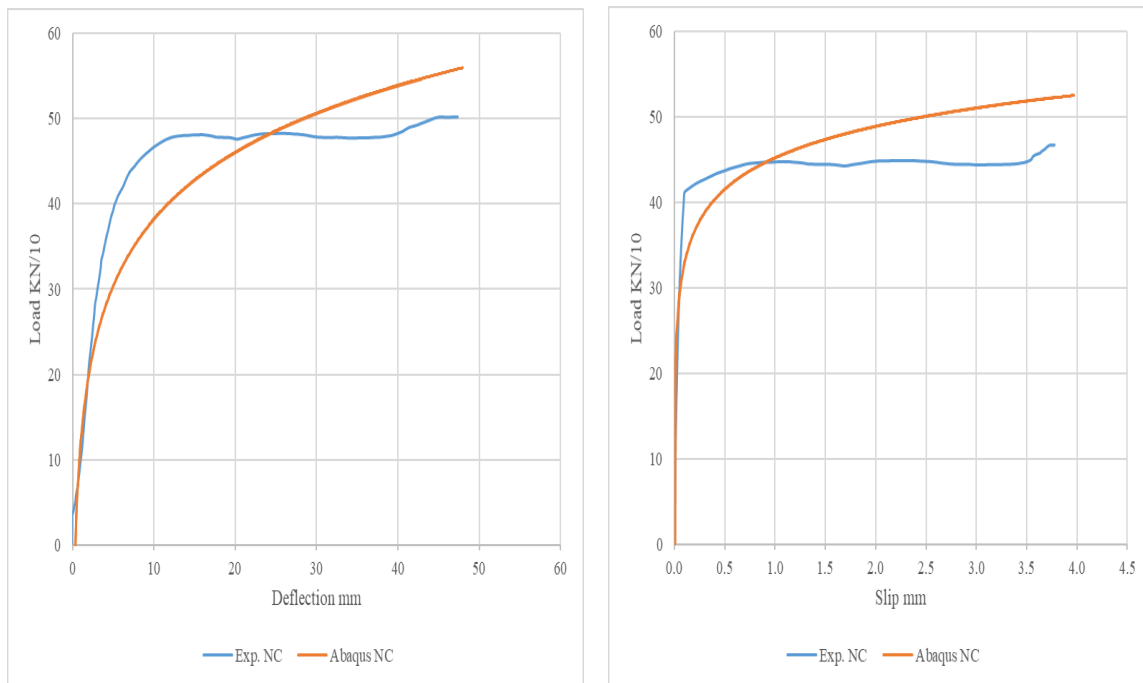

Fig.35 Load-deflection variation for the experimental and numerical results.



c. Y-rebar Ø10 mm with NC



d. Y-Rib C.P. with NC

Fig.35 continued.

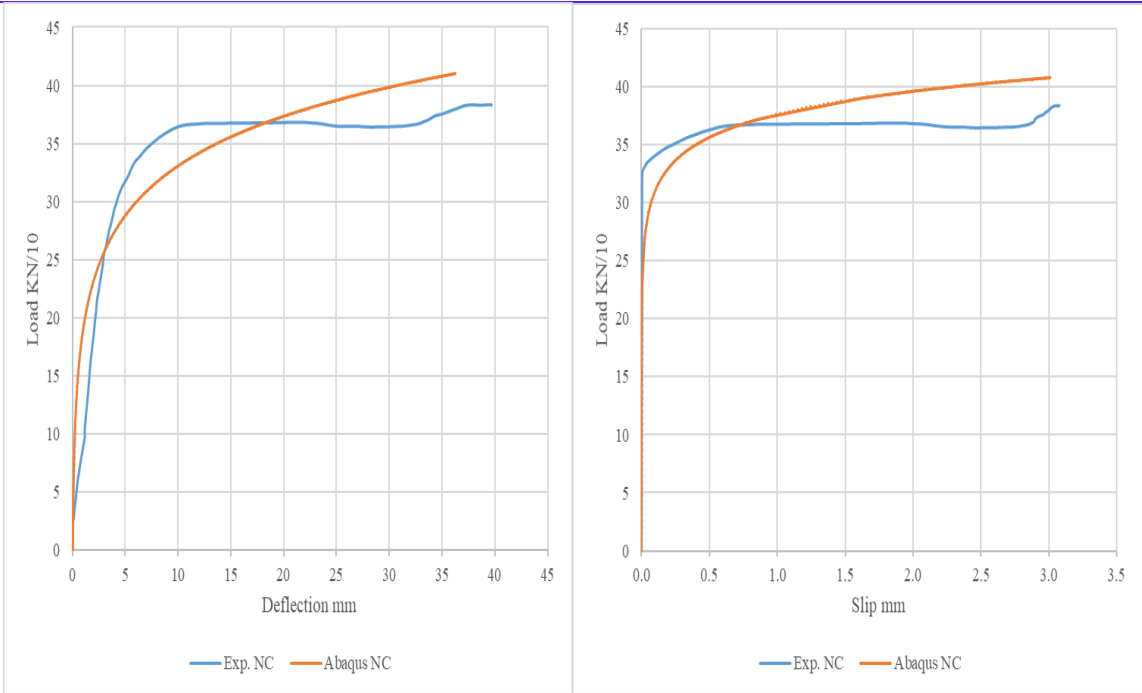

f. 60% P.I. C.P. with NC

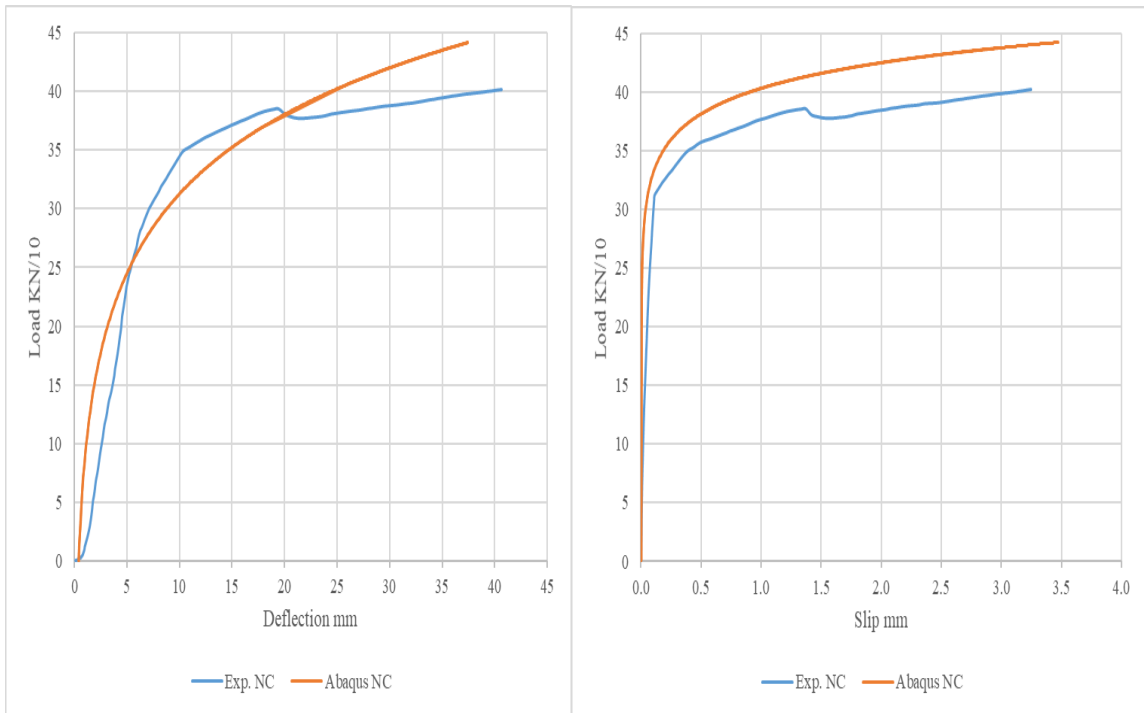

g. 70% P.I. C.P. with NC

Fig.35 continued.

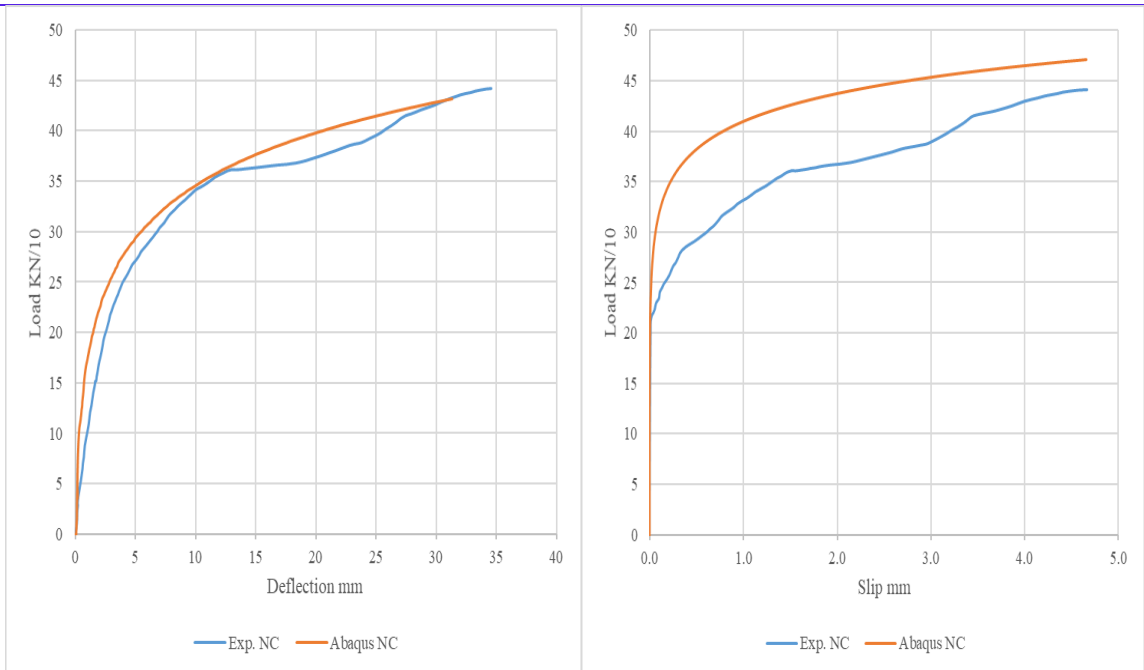

h. Y-Rib S.P. with NC

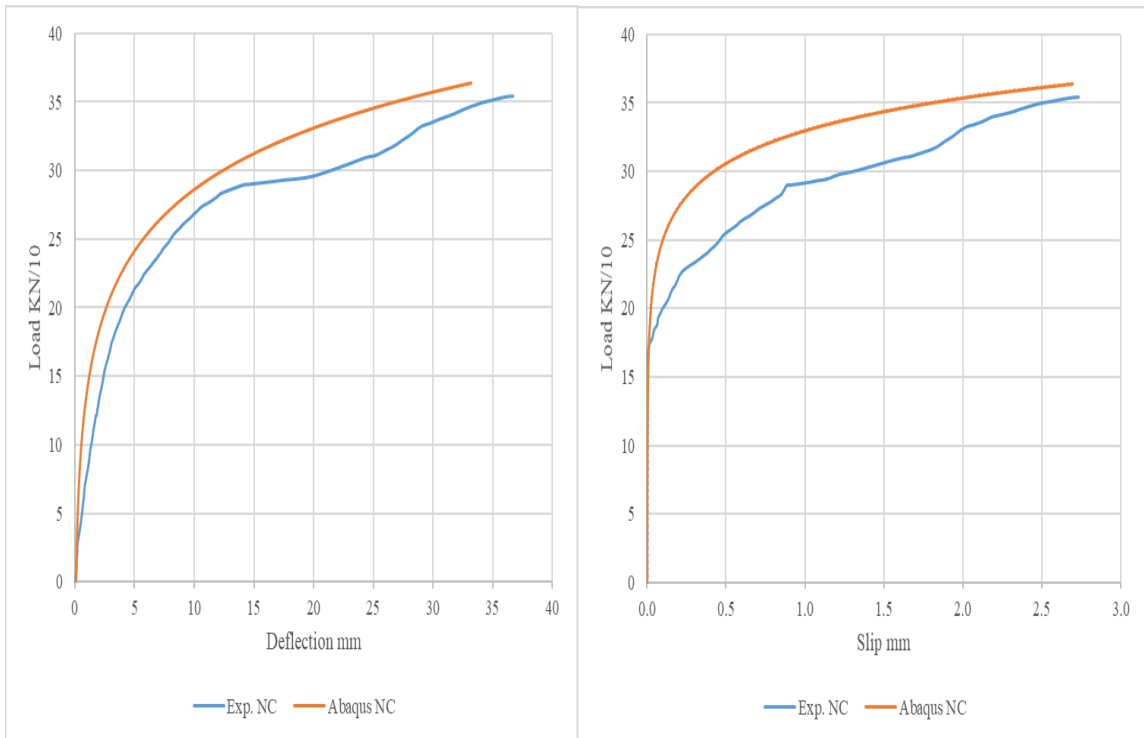

i. 60% P.I. S.P. with NC

Fig.35 continued.

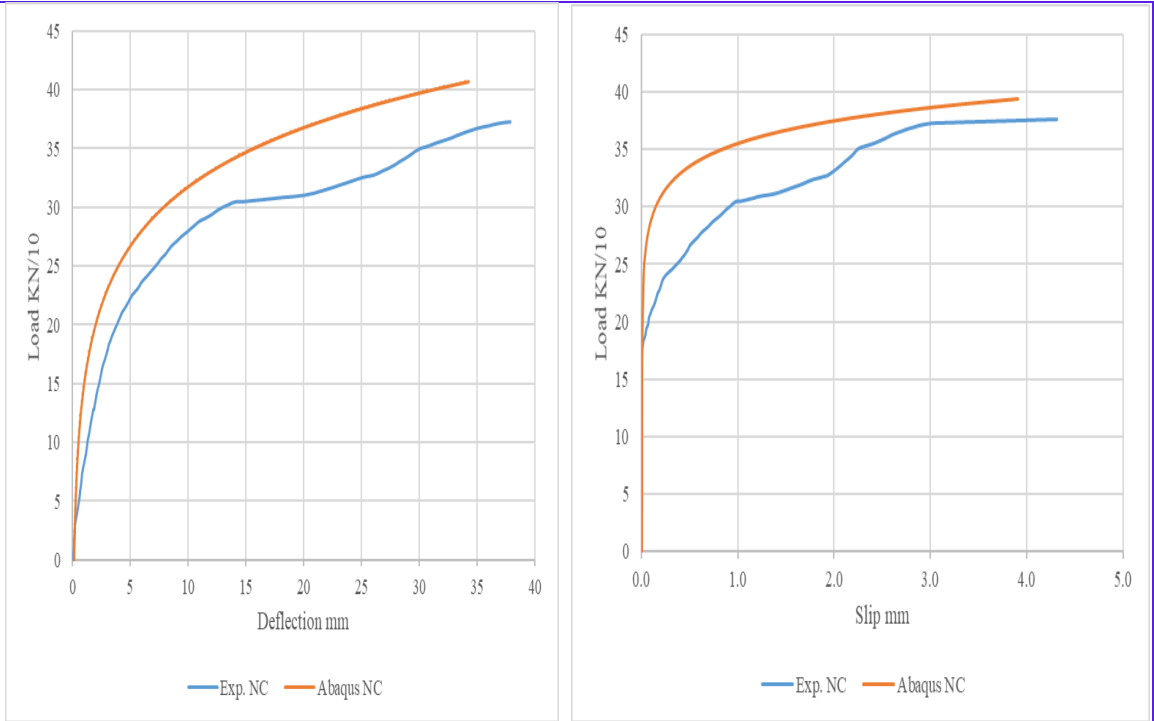

j. 70% P.I. S.P. with NC

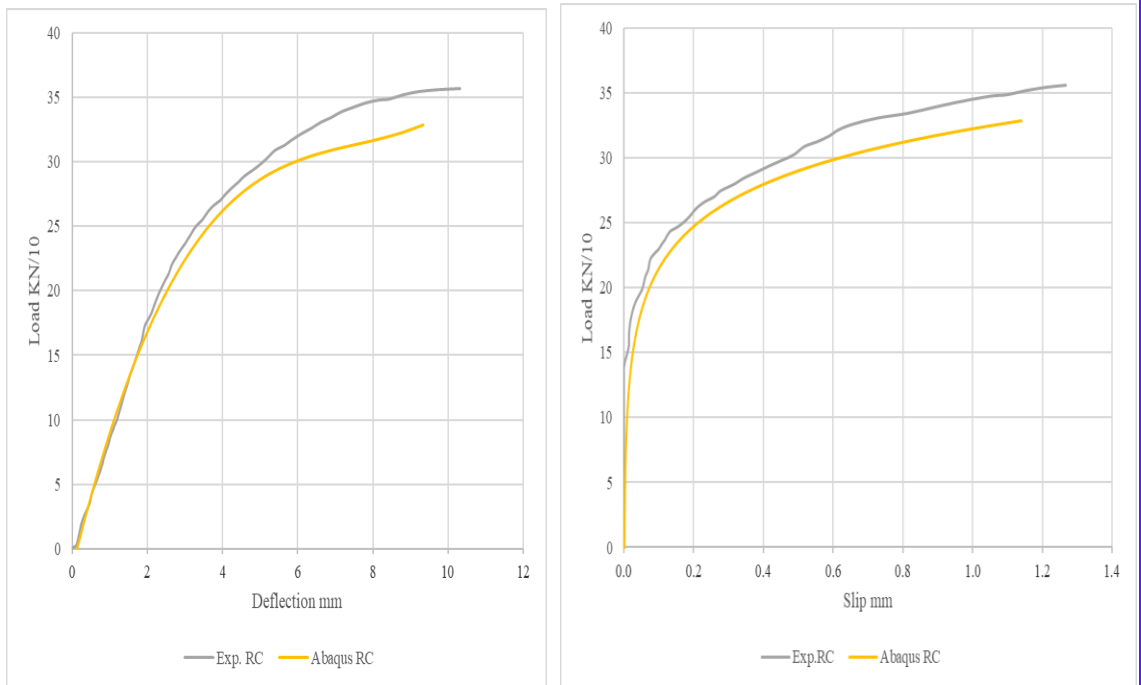

k. Stud with RC

Fig.35 continued.

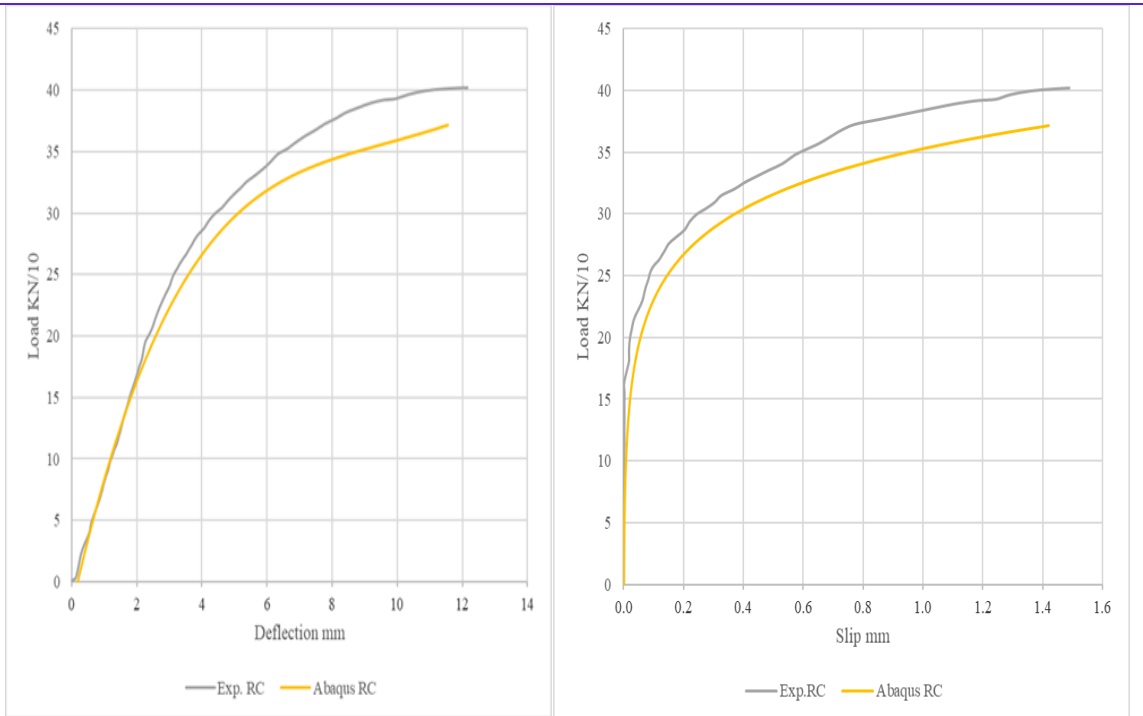

l. Rebar Ø20 mm with RC

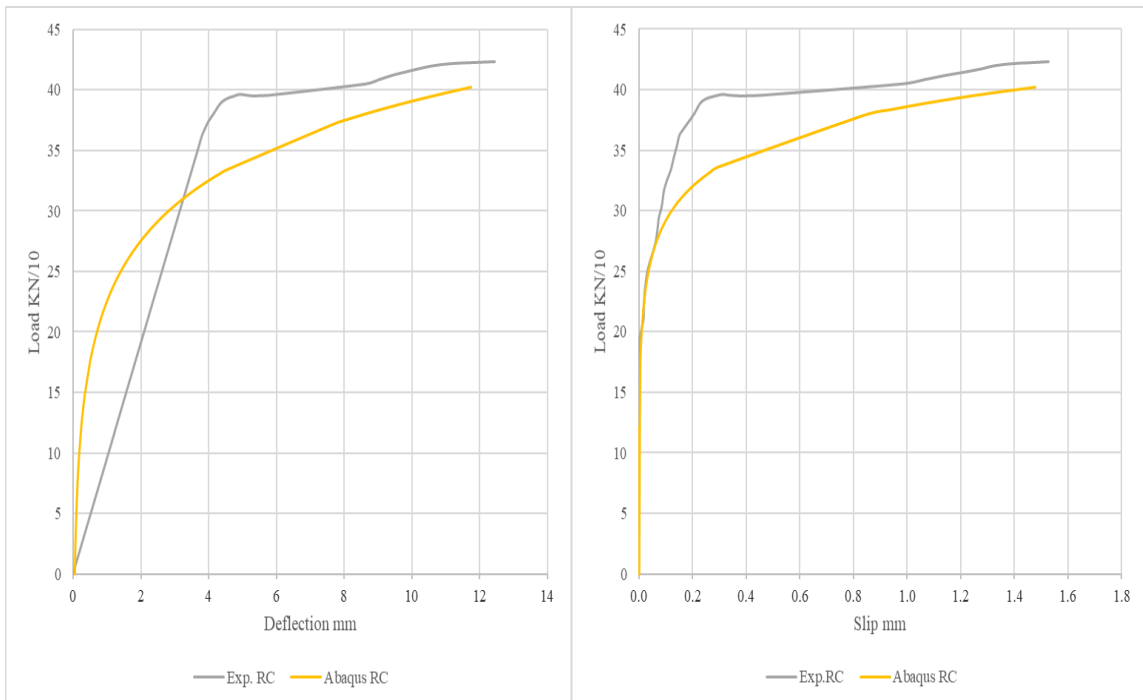

m. Y-rebar Ø10 mm with RC

Fig.35 continued.

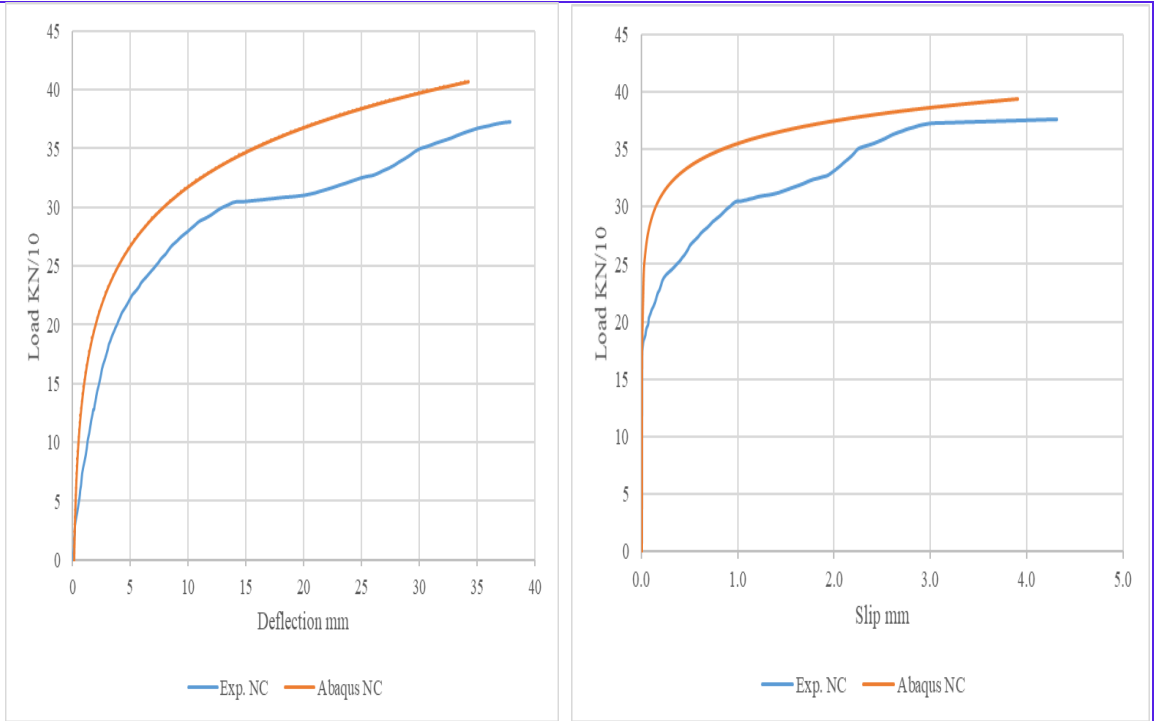

j. 70% P.I. S.P. with NC

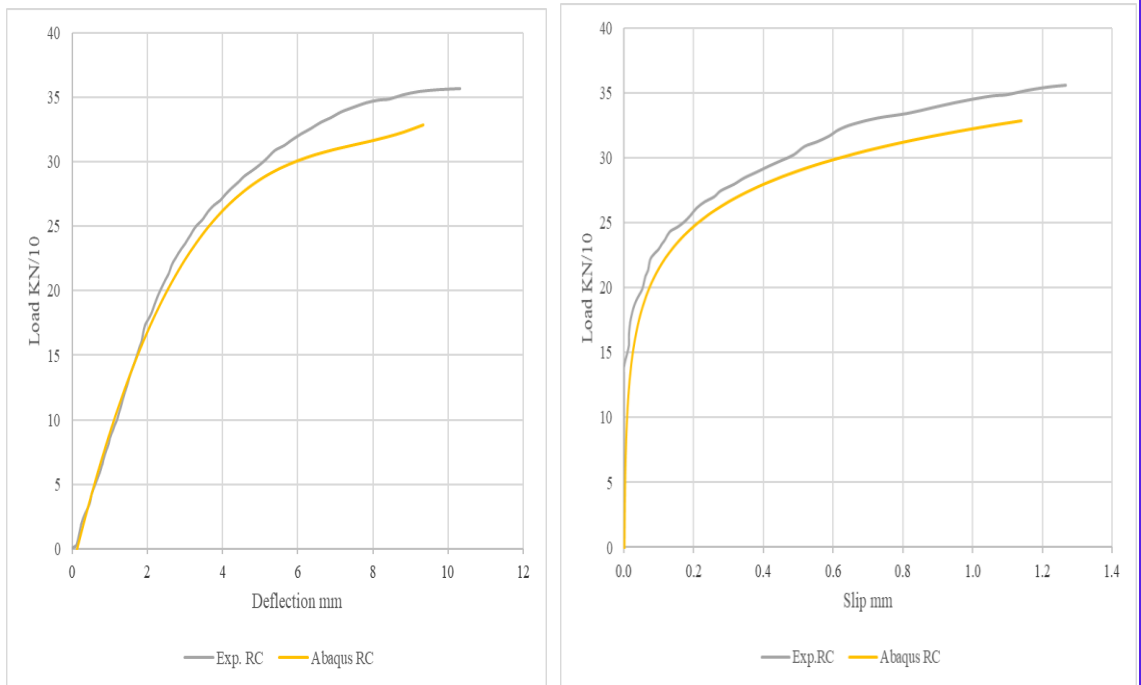

k. Stud with RC

Fig.35 continued.

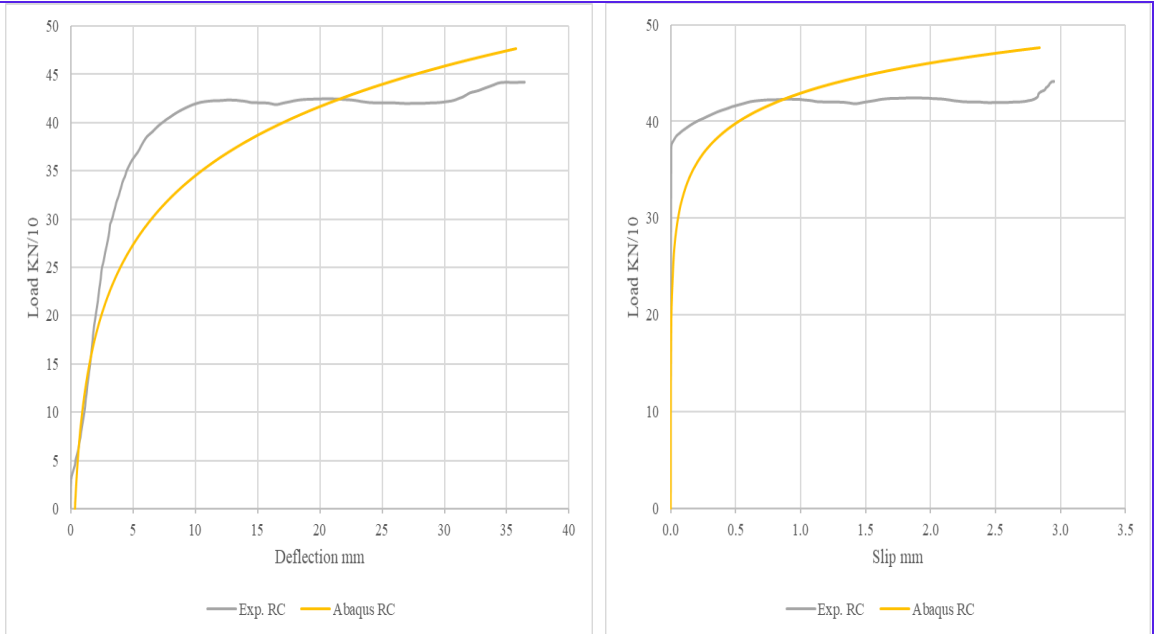

n. Y-Rib C.P. with RC

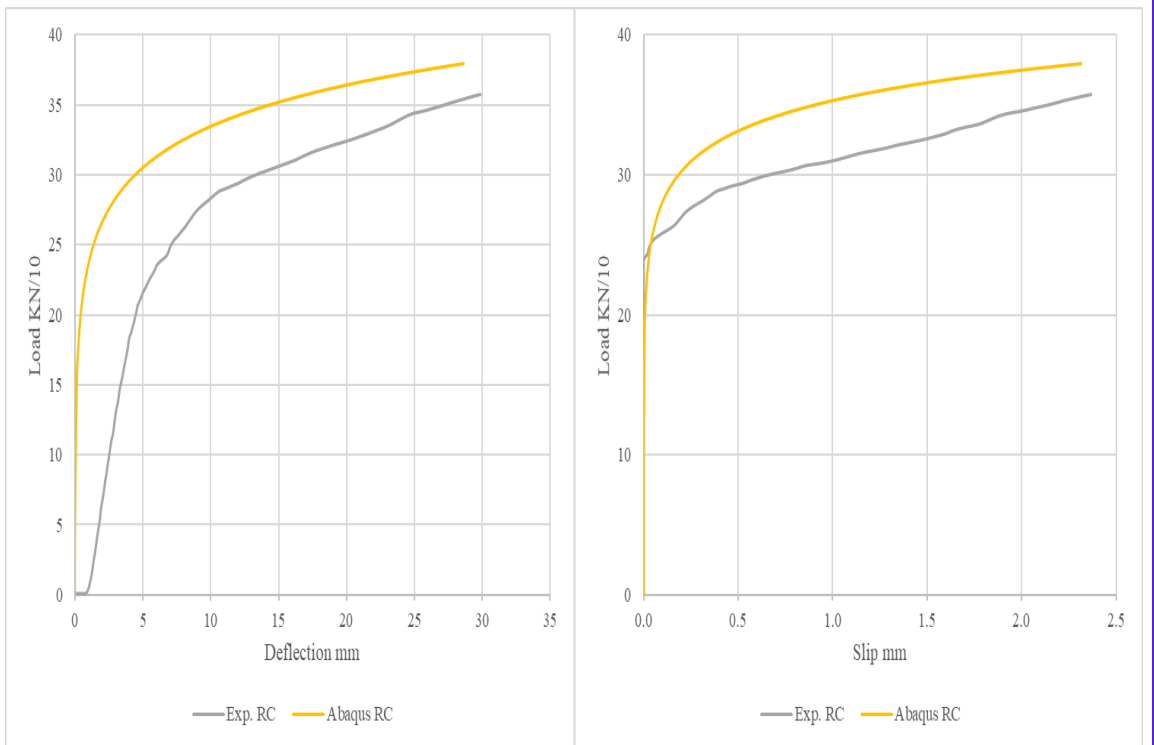

o. 60% P.I. C.P. with RC

Fig.35 continued.

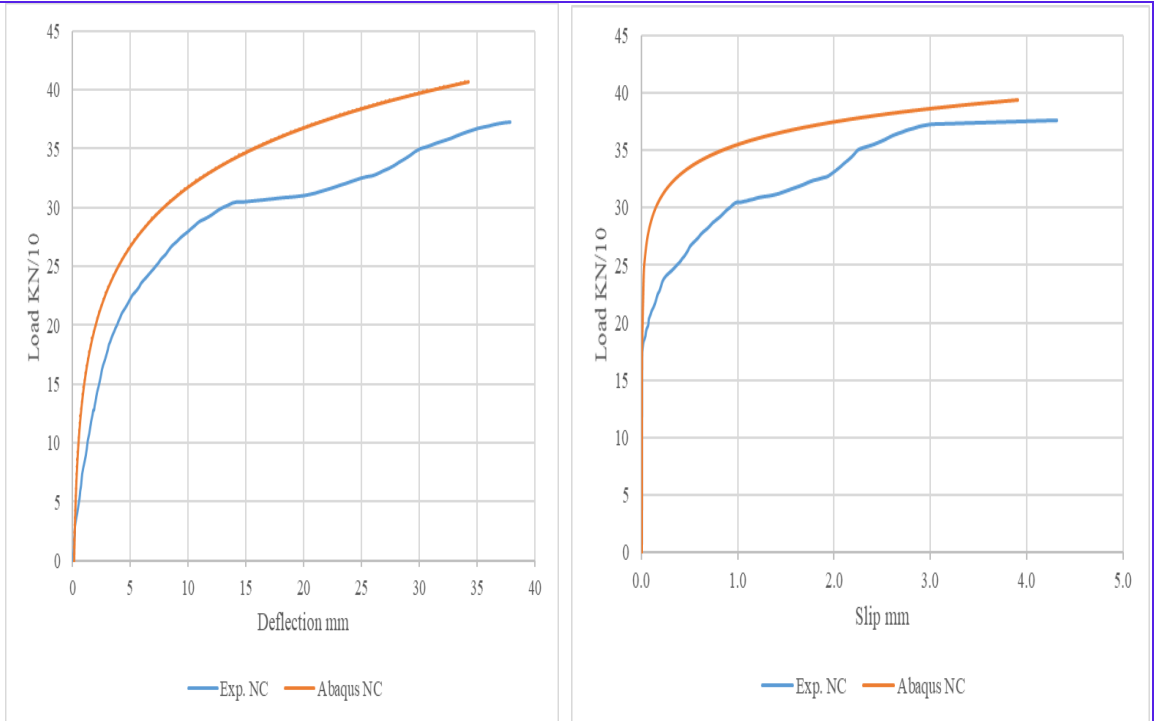

p. 70% P.I. S.P. with NC

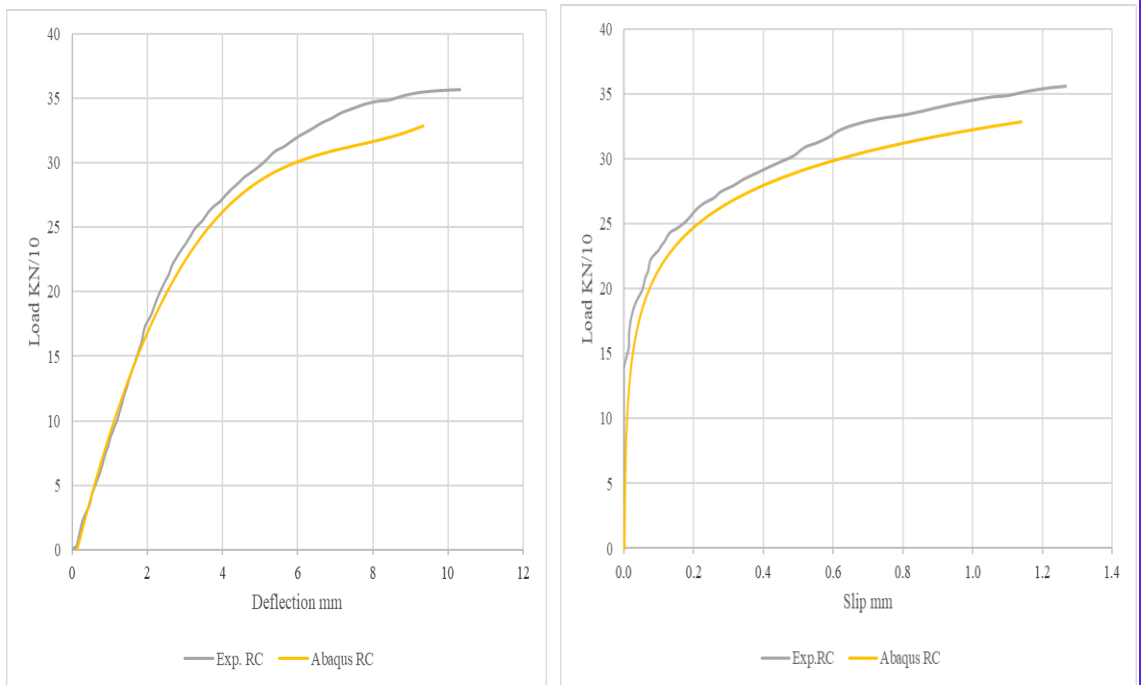

q. Stud with RC

Fig.35 continued.

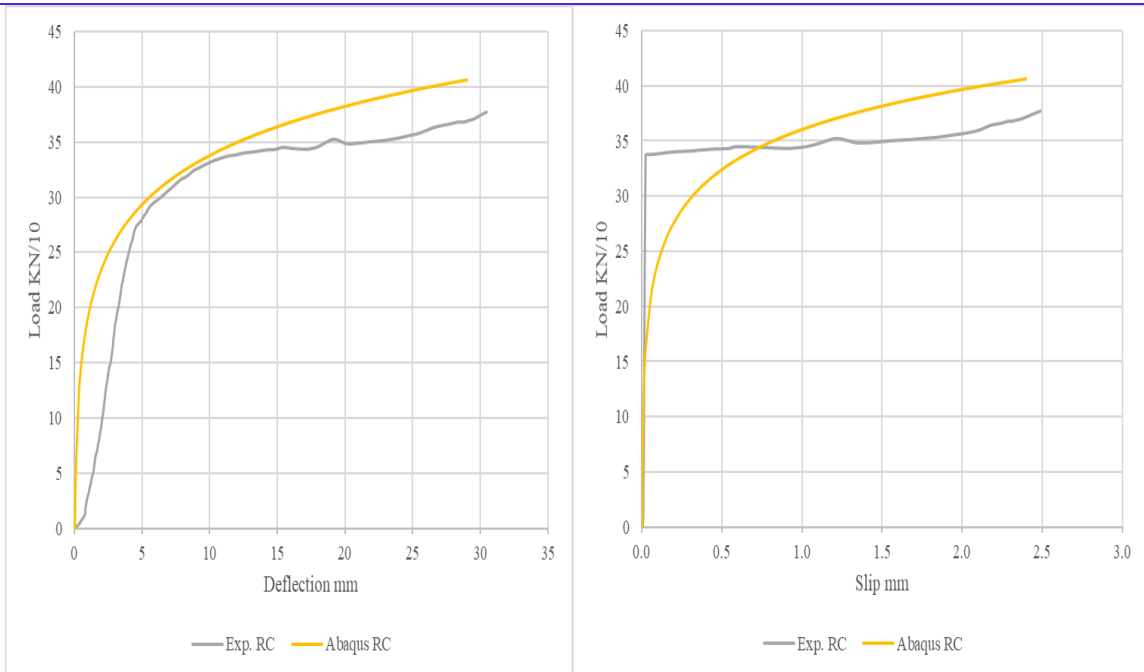

r. 0% P.I. C.P. with RC

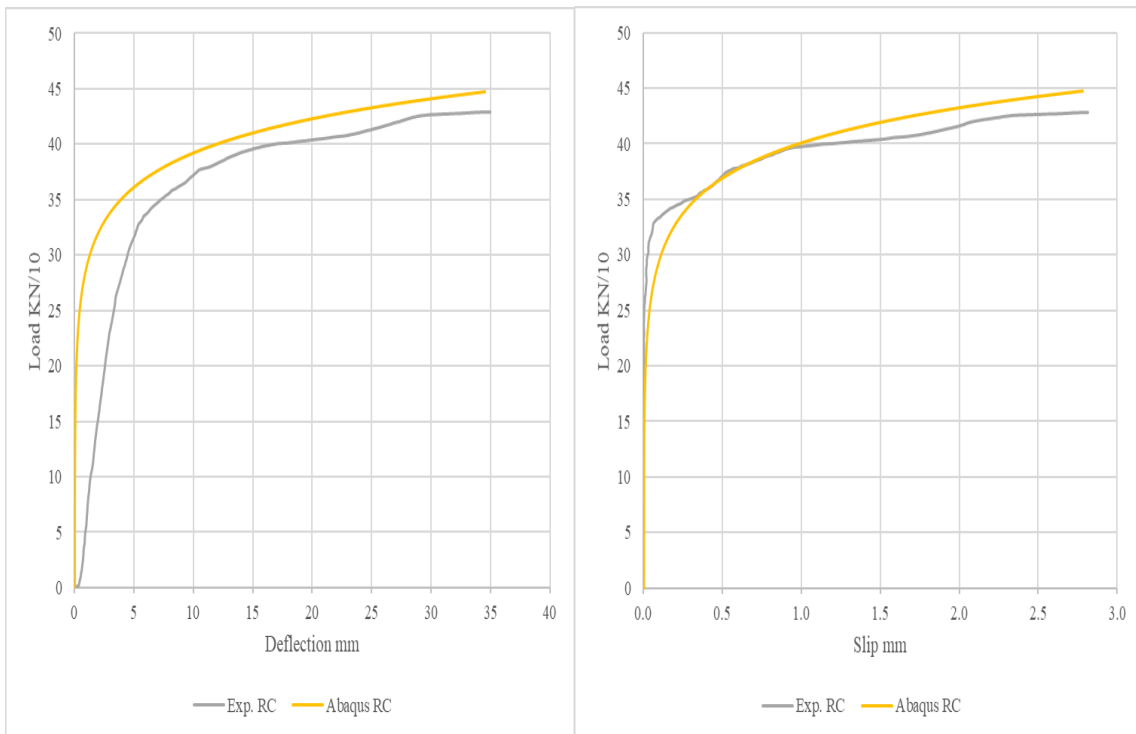

s. Y-Rib S.P. with RC

Fig.35 continued.

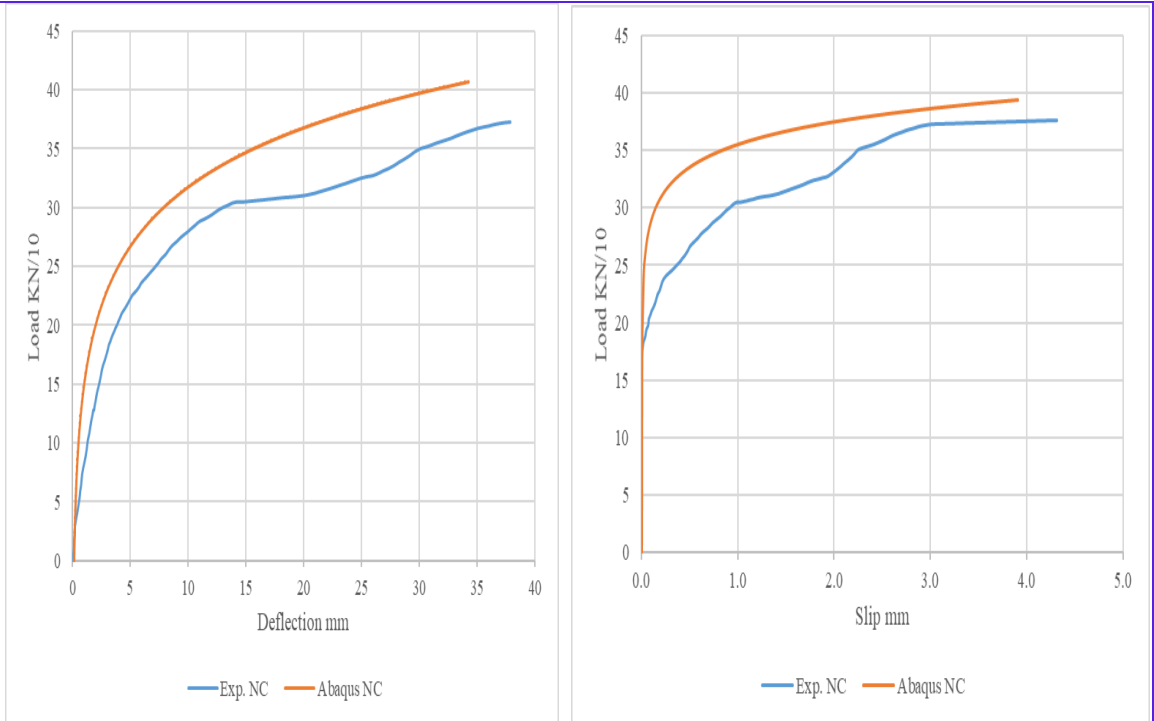

j. 70% P.I. S.P. with NC

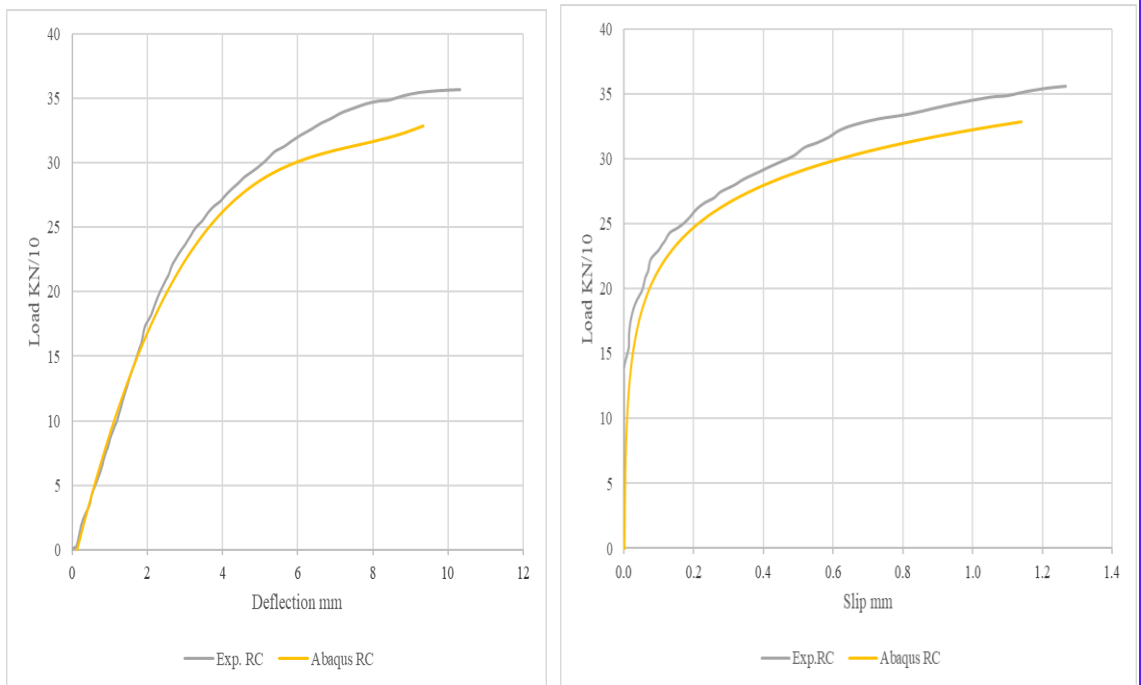

k. Stud with RC

Fig.35 continued.

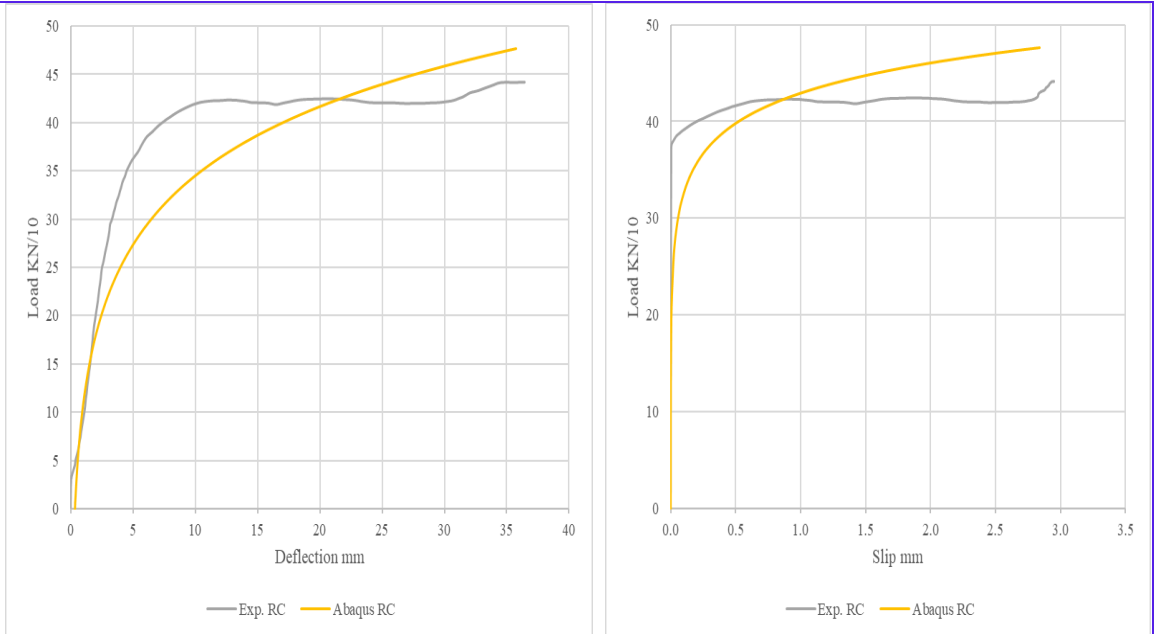

n. Y-Rib C.P. with RC

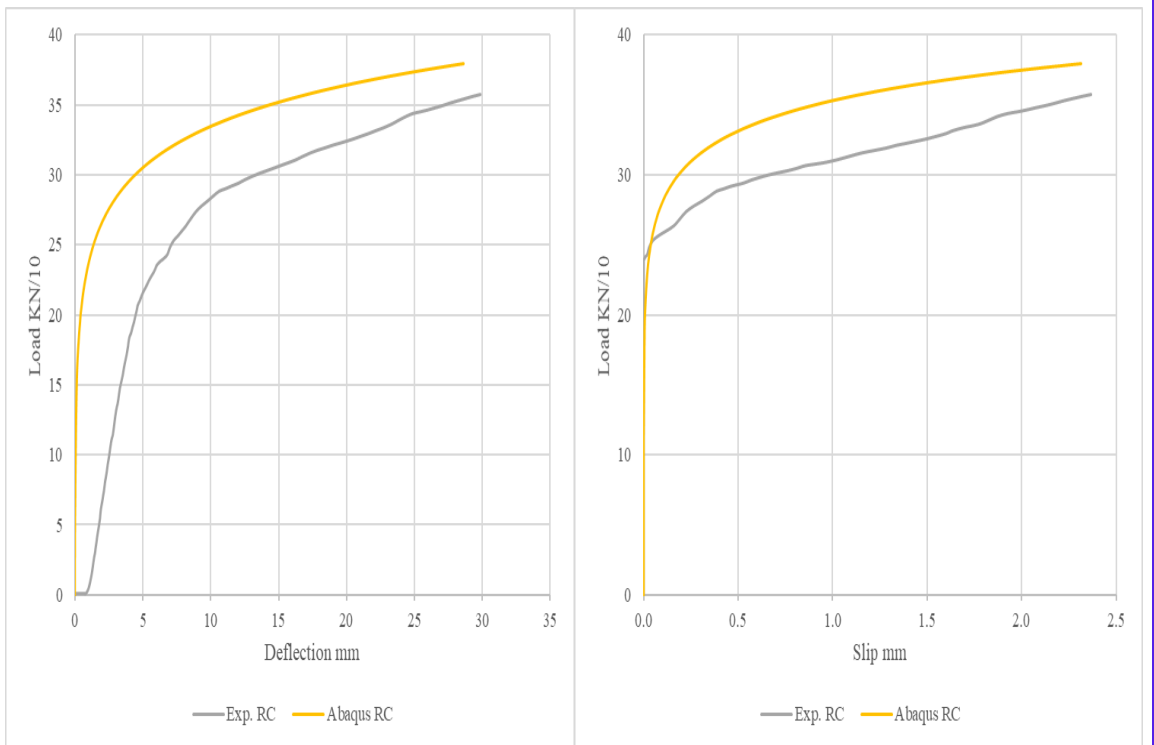

o. 60% P.I. C.P. with RC

Fig.35 continued.

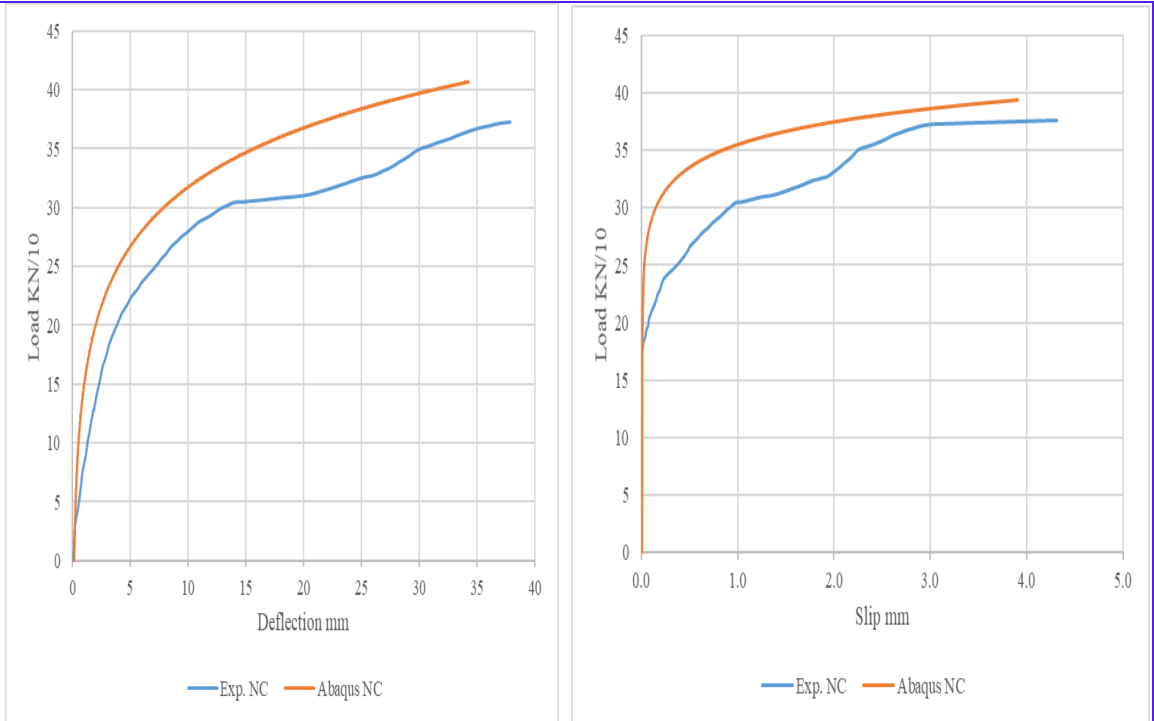

p. 70% P.I. S.P. with NC

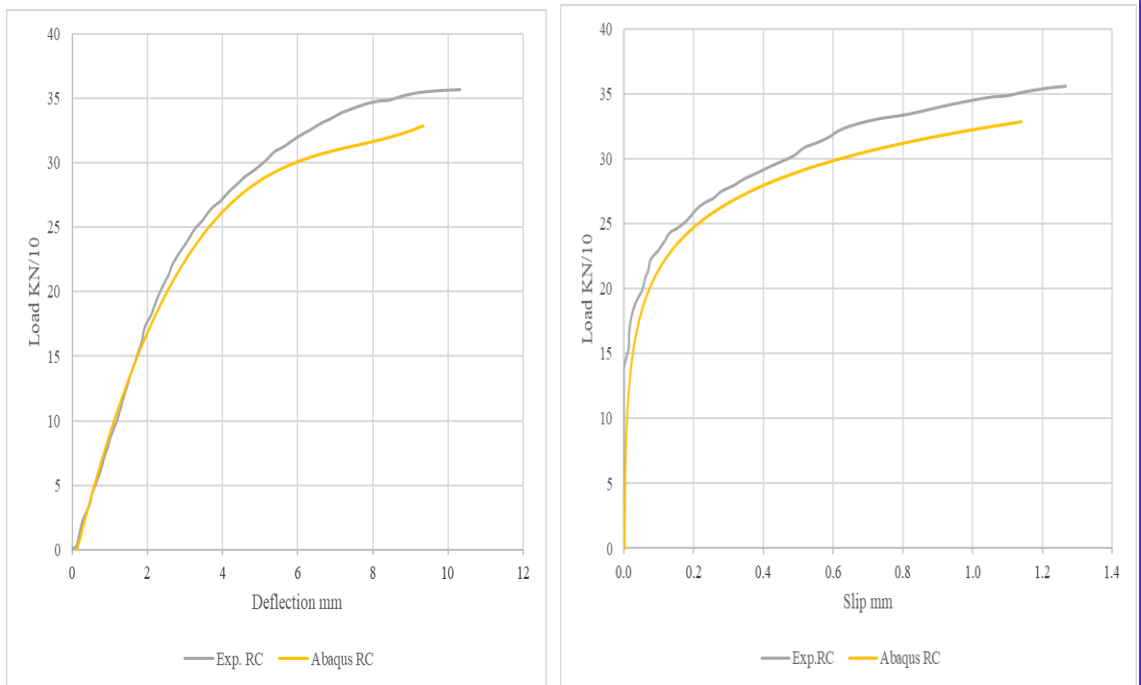

q. Stud with RC

Fig.35 continued.

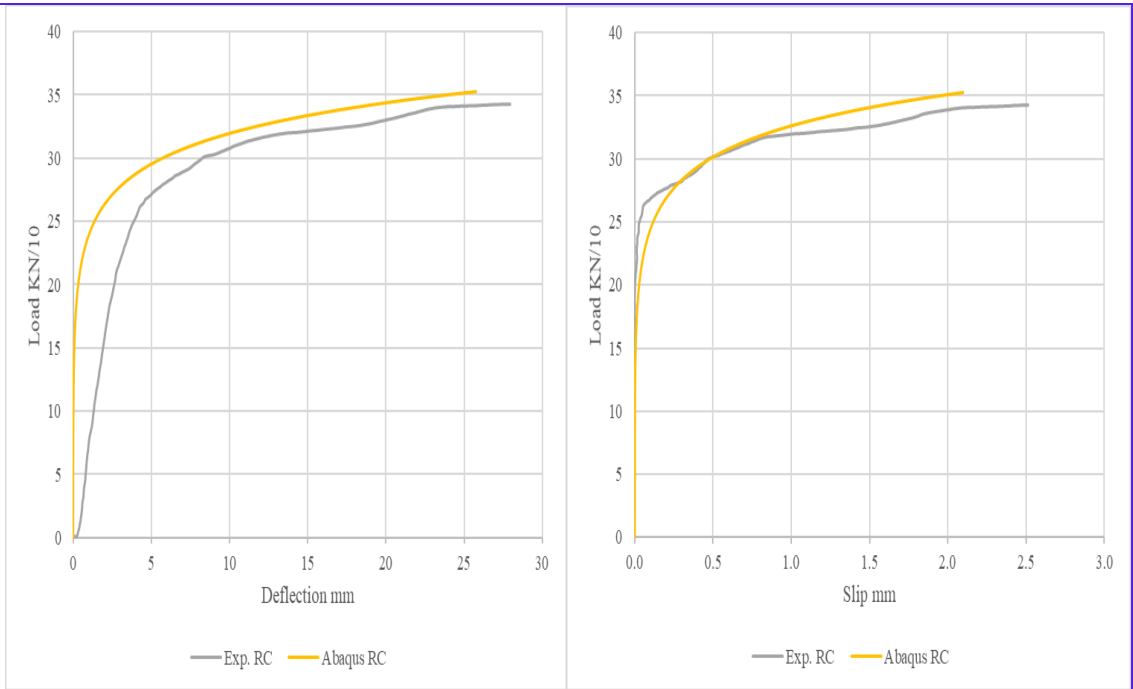

r. 60% P.I. S.P. with RC

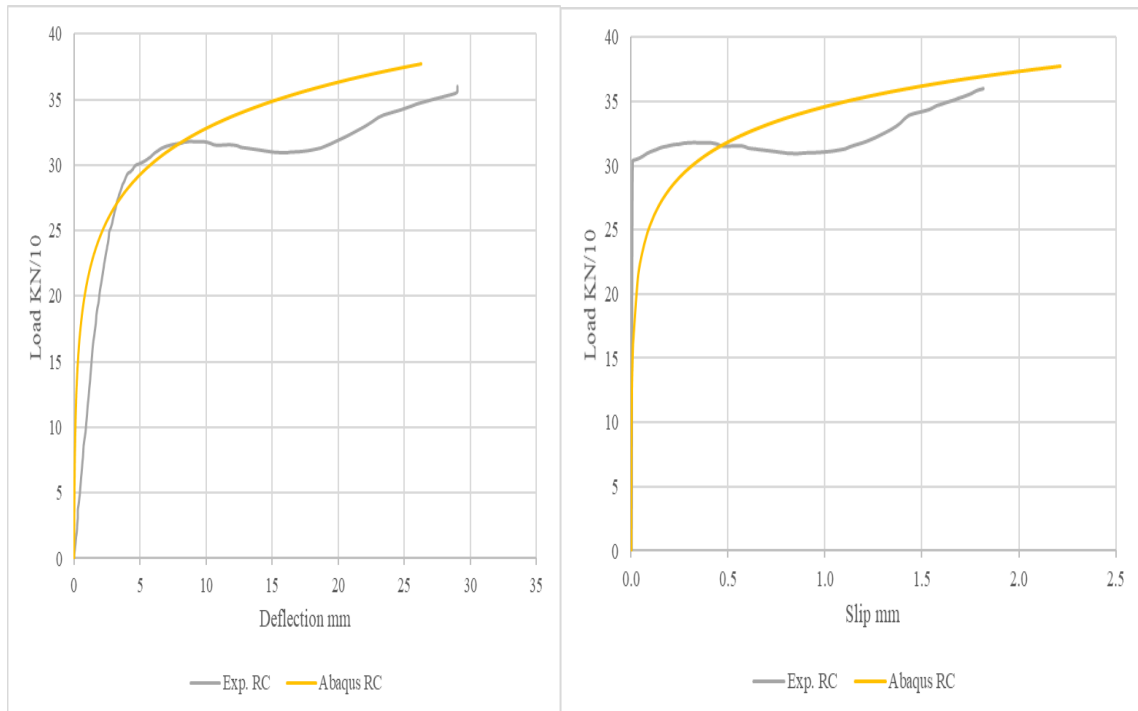

s. 70% P.I. S.P. with RC

Fig.35 continued.

4. Conclusion

Based on the results of the laboratory study, the following conclusions can be drawn:

- 1 - Using of recycled concrete as a partial replacement for a portion of the fine aggregate by 30% demonstrates the potential to yield outcomes remarkably akin to those observed when using conventional concrete. within the bounds of the studied compressive strength. Consequently, a reduction in concrete waste generation and diminished consumption of natural gravel can be achieved.
- 2 - The results showed that the use of connectors that were studied gives higher results than the results that we get when we use Stud Shear connectors, which offers a more economical alternative solution as it is used using materials present at the work site compared to the high -cost of Stud Shear connectors, also it is a quick solution The materials used are available in the markets compared to the Stud Shear s, which are often not available in the markets and if they are in specific markets and cities, and it may take it and reach it for a long time
- 3 - The results unequivocally demonstrate that the using of Y-Rib shear connectors gives the most optimal outcomes among all used connectors, with Type Y-Rib Checker Plate in particular exhibiting superior performance. This can be attributed to the unique interlocking mechanism of these two connector types with the concrete substrate, coupled with the robust bonding characteristics inherent in checker plate connectors. Furthermore, it stands out as the superior choice under failure conditions. Composite beam connected by (Stud Shear, R20 mm and Y-R10mm) connectors experienced failure due to partial separation between the concrete and steel parts due to slip. In contrast, the connectors manufactured as Y-Rib shear connector checker and smooth plates maintained their structural integrity, acting as a unified section without experiencing partial separation between the two constituents.
- 4 - The using of Type Y-rib shear connectors is considered easier and offers greater precision in operations, achieved through aligning both the horizontal and vertical orientations of the plate and welding on both sides of the plate. This is in contrast to the Stud Shear type, which is challenging to implement on-site with the same level of precision.

5. References

- [1] Kim SH, Jung CY, Ahn JH. Ultimate strength of composite structure with different degrees of shear connection. *Steel Compos Struct* 2011;11(5):375–90.
- [2] Papastergiou D, Lebet JP. Design and experimental verification of an innovative steel–concrete composite beam. *J Constr Steel Res* 2014;93:9–19.
- [3] KimSH, Choi KT, Park SJ, Park SM, Jung CY. Experimental shear resistance evaluation of Y-type perfobond rib shear connector. *J Constr Steel Res* 2013;82:1–18.
- [4] Kim SH, Park SJ, HeoWH, Jung CY. Shear resistance characteristic and ductility of Ytype perfobond rib shear connector. *Steel Compos Struct* 2014 (in press).
- [5] Shan, B., Wang, Z. Y., Li, T. Y., & Xiao, Y., “Experimental and analytical investigations on short-term behavior of glubam-concrete composite beams.,” *Journal of Structural Engineering*, vol. 146, no. 3, p. 04019217, 2020.
- [6] Lin, W., “Experimental investigation on composite beams under combined negative bending and torsional moments.,” *Advances in Structural Engineering*, vol. 24, no. 7, pp. 1456-1465, 2021.
- [7] Kim, J., “Construction and demolition waste management in Korea: Recycled aggregate and its application.,” *Clean Technologies and Environmental Polic*, no. 23, pp. 2223-2234, 2021.
- [8] Wu, X., Kang, T. H. K., Lin, Y., & Hwang, H. J., “Shear strength of reinforced concrete beams with precast High-Performance Fiber-Reinforced Cementitious Composite permanent form.,” *Composite Structures*, vol. 200, pp. 829-838, 2021.

- [9] Singh, M., Sheikh, A. H., Ali, M. M., Visintin, P., & Griffith, M. C., “Experimental and numerical study of the flexural behaviour of ultra-high-performance fibre reinforced concrete beams.,” *Construction and Building Materials*, vol. 138, pp. 12–25, 2017.
- [10] Sener, K. C., Varma, A. H., & Gallocher, S., “Experimental study on Modular Steel-Concrete construction assembled with a novel fabrication technology.” 4th Conference on Structural Mechanics in Reactor Technology, 2017.
- [11] Iraqi Standard Specification, IQS No. 5/2019, Portland cement, Central Organization for Standardization and Quality, Baghdad, 2019.
- [12] Iraqi Standard Specification, IQS No. 45/1984, Aggregate from natural sources for concrete and construction, Central Organization for Standardization and Quality, Baghdad, 1984.
- [13] ASTM C494/C494M-19, Standard Specification for Chemical Admixtures for Concrete, ASTM International, 2019.
- [14] British Standard BS:(1881-125-2013), Testing concrete Part 125: Methods for mixing and sampling fresh concrete in the laboratory, 2013
- [15] British Standard BS-EN-12390-1-2021, Testing hardened concrete, 2013
- [16] ASTM C39/C39M-20, Standard Test Method for Compressive Strength of Cylindrical Concrete Specimens, ASTM International, 2020.
- [17] ASTM C469/C469M-14e1, Standard Test Method for Static Modulus of Elasticity and Poisson’s Ratio of Concrete in Compression, ASTM International, 2014.