

See discussions, stats, and author profiles for this publication at: <https://www.researchgate.net/publication/348216110>

# MODULATING A CENTRIFUGE SPREADER DISC AND EVALUATING PERFORMANCE UNDER SOME DIFFERENT OPERATING FACTORS

Article in *International Journal of Agricultural and Statistics Sciences* · January 2021

CITATIONS

0

READS

18

3 authors, including:



[Assad Khudher](#)

university of basra

11 PUBLICATIONS 0 CITATIONS

[SEE PROFILE](#)



[Salim Almaliki](#)

University of Basrah

16 PUBLICATIONS 54 CITATIONS

[SEE PROFILE](#)

Some of the authors of this publication are also working on these related projects:



ARTIFICIAL NEURAL NETWORK AND STEPWISE APPROACH FOR PREDICTING TRACTIVE EFFICIENCY OF THE TRACTOR (CASE JX75T) [View project](#)



DYSONA Journals in Life and Applied Sciences [View project](#)



**ORIGINAL ARTICLE**

## MODULATING A CENTRIFUGE SPREADER DISC AND EVALUATING PERFORMANCE UNDER SOME DIFFERENT OPERATING FACTORS

Assad Yousif Khudher\*, Majed Saleh Himoud and Salim Acher Almaliki

Department of Agricultural Mechanization, College of Agriculture, University of Basrah, Iraq.

E-mail: [assad.khudher@uobasrah.edu.iq](mailto:assad.khudher@uobasrah.edu.iq)

**Abstract:** Centrifugal spreader machine is a farm implement commonly used for spreading seed and fertilizer. However, the quality of the resulting spread pattern in the field can be poor, Therefore, the study aims to test a modulating disc ( $A_2$ ) and control disc ( $A_1$ ) and find the effect of change on the machine performance using different of forward speeds, disc speed, urea fertilizer and barley seeds. Results showed that use of the disc  $A_2$  reduces the coefficient of variation (CV%). The machine reached its best performance when using  $A_2$  with the forward speed of 12 km / h and the speed of the disc 450 rpm by 5.5 and 7.6 for spreading the barley and urea, respectively.

**Key words:** Broadcast spreaders, Uniformity distribution, Distribution pattern.

### Cite this article

Assad Yousif Khudher, Majed Saleh Himoud and Salim Acher Almaliki (2020). Modulating a centrifuge spreader disc and evaluating performance under some different operating factors. *International Journal of Agricultural and Statistical Sciences*. DocID: <https://connectjournals.com/03899.2020.16.1799>

### 1. Introduction

A centrifugal spraying machine is an agricultural tool commonly used to spread seeds, lime, fertilizers, sand, thaw, etc. In more countries, more than 90% of fertilizers are distributed using rotary disc distributors. The popularity of turntable dispensers lies in their relatively low cost and relatively high accuracy. Besides, it allows a large working width and easy maintenance. However, the quality of the resulting field spread diagram may be poor. Excessive application variation is undesirable as it adversely affects crop or pasture yields and may increase leaching losses. If a zone can be observed in crops, the variation of the overlap is likely to exceed 40% and the yield loss will be 20% or more. It is now generally accepted that the spatial variation coefficient (CV) should not exceed 15% for nitrogen fertilizers. For other fertilizer types, a CV of at most 25% is acceptable [Ian and Grafton (2016)]. Large dose fluctuations are avoided by using overlapping patterns. In theory, 100% uniform coverage can be achieved if you drive exactly in an adjacent lane. This leads to large differences in dispersion models

depending on the properties of the particles (e.g. coefficient of friction, shape) [Hofstee (1995)] as well as prevailing weather conditions (e.g. humidity). At working widths of 36 m and more, the dispersion models are less and less uniform [Grafton *et al.* (2015)].

Many new machines use double discs which rotate in opposite directions. This improves uniformity and can increase the spreading distance. Many parameters affect the performance of the rotary table fertilizer spreader, such as B. geometry (size and shape of the disc, landing site of the material, shape and size of the feed gates, shape, door length and direction), the speed of the turntable. JiMan *et al.* (2018) found that when using four blades, the coefficient of variation (CV) was 11-13% less than that of three points and that the CV at 500 rpm of the blade speed was 9-12% lower than the 400 and 600 rpm. The paper analyzes the movement of idealized homogeneous spherical fertilizer particles along with the right pallet, which is attached to a flat rotating disc. The movement of particles along the dawn is described by the hyperbolic cosine function, which is the solution of the usual inhomogeneous second-order

differential equation with constant coefficients. A solution of this kind is an approximation of the actual movement of fertilizer particles along the radial blade, which is attached to a horizontal disc that rotates at a constant angular velocity. However, it can be very useful to optimize the design of centrifugal spreaders [Tomantschger *et al.* (2018), Vera *et al.* (2018)]. Differently shaped blades on the uniformity of the fertilizer distribution in the single rotating disc transmitter were used with different flow rates. The combinations used in the study were the straight vane in combination with the forward curved 5', the forward curved 10', the backward curved 5 and the backward-curved 10 scoops "10 , scoops" study die showed that the combination of the differently shaped blades on the spinning disc had a significant influence on the uniformity of the fertilizer distribution [Yildiran and Mazhar (2012)]. A mathematical model of the movement of fertilizer particles on the spinning disc and in the air has been created. The Langevin stochastic differential equation was used to describe the random disturbances affecting the fertilizer particles moving on the disc spreader. Modeling the spread of mineral fertilizers with tablet dispensers can be used to improve existing dispensers and to design new ones [Przystupa *et al.* (2016)]. A method has been suggested that uses the control of the position of drops of compost particles on a rotating disk to improve symmetry in the dispersion model. The results showed that a dispersion model with an acceptable CV of less than 15% could still be found, even if the distribution was obtained from a primitive flat disc with straight radial ribs. A dual-use agrochemical disc applicator for crops was developed and tested for uniformity of the granular fertilizer distribution model / uniformity of liquid chemicals of droplet size when spraying agrochemicals. The results for NPK granular chemicals showed that at low (50 kg / ha) and high (150 kg / ha) application rates at a disc speed of 550 rpm, the distribution pattern was shifted to the left, while the medium distribution pattern (100 kg / ha) application rates were good [Abubakar and Ahmad (2012)]. The discs used in rotary fertilizer spreaders are flat or conical. Unlike flat discs, conical discs project fertilizer with an upward component of speed and increase the distribution distance. The influence of the angle of the cone and the speed of rotation of the disc on the uniformity of the distribution was studied with different flow rates using triple

superphosphate. The uniformity of the distribution deteriorated with the increase in the angle of the disc cone (flat disc 0°, 10° and 20°) and improved with the increase in the diameter of the disc (405, 540 and 810 min<sup>-1</sup>) with all the diameters of the openings (30-50 mm) [Yildiran (2020)]. There are a number of tray test methods used worldwide to assess the spreading accuracy of fertilizer spreaders that are used to calculate all differences in the spreading model, including ISO (i), ISO (ii), ASAE S341.2, European Standard, Accu-Spread in Australia and Spread-Brand in New Zealand. The results showed that there were significant deviations in the certifiable peak width, which were calculated with the different methods. The arrangement of the shells  $\pm 5$  m from the spread line had the greatest influence on the calculated final width [Lawrence *et al.* (2006)]. The bowl spacing of 1.0 m showed a strong correlation with the gaps of 0.5 m, while maintaining the normal distribution pattern of the spread fertilizer, albeit in a slightly lower definition [Wilson and Grafton (2019)]. Replacing right-angled disc blades with arcuate blades can reduce the coefficient of friction between the particles and the surface of the blades, thereby improving the distribution coefficient and the projection width. The objective of the study is therefore to test a new prose disc (A<sub>2</sub>) compared to a conventional disc (A<sub>1</sub>) and to determine the influence of the change on the distribution coefficient using different soil speeds, fertilizers made from urea and barley seeds.

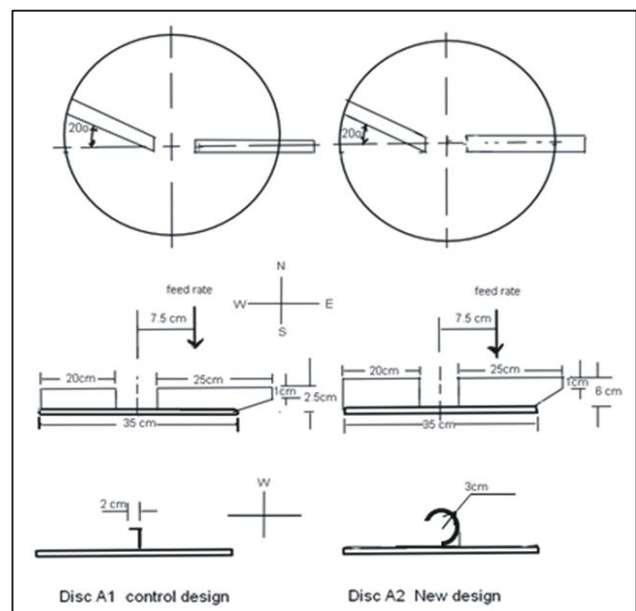

**Fig. 1:** Disk A<sub>1</sub> and disc A<sub>2</sub>

**Table 1:** Physical properties of urea and barley.

Particles	Bulk density (kg/m <sup>3</sup> )	Mean diameter of grain (mm)	Moisture content (b.w) (%)
Barley	948	2.5±0.21	4.6±0.4
Urea	986	2.33±0.8	dry

**2. Materials and Methods**

• **Disc of spreader:** The machine discs were manufactured by modulating the wings from straight to curved by a diameter of 3 cm, as they obtained an increase in dimensions as shown in Fig. 1A<sub>2</sub> compared to the straight wing (Fig. 1A<sub>1</sub>).

• **Broadcast spreader:** CASE lil JX75T double disk spreader was used in test, hopper capacity 300 kg (volume 0.4 m<sup>3</sup>), mixer of materials inside the hopper and adjustable orifice for the flow rate using mechanical control (not an electronic or electricity).

• **Particles:** Urea fertilizer (granulated) and barley seeds, Physical properties of Particles are described in Table 1.

• **Application rate:** Application rate of barley is 170 kg/ha in most fields if the drilling sowing machine is used. If the broadcast spreader is used, agriculture is preferred at an application rate not exceeding 20%. The current study adopted 200 kg/ha and 200 kg/ha urea.

• **Experimental plan:** Two test were conducted, the first with urea fertilizer and the second with barley seeds. Each test was performed by the following



**Fig. 2:** Broadcast spreader and collecting trays

method  $2A \times 2R \times 3S \times 3r$ , where A: (A<sub>1</sub> disc and A<sub>2</sub> disc), R: (450 and 540) rpm of disc speed, S: (4.10, 7.5 and 12) km/h of broadcast forward speed and r: Repeaters.

• **Forward speed and swath width:** The spreader hopper fell out particles and starting move by choosing a Forward speed of broadcast (gear and engine speed), then the gate opened to spread on ground and find the work width (Fig. 2), This was repeated with the three forward speeds and for both barley and urea.

• **Flow rate or feed rate:** Flow rate determined by each forward speed. The mathematical equation proposed by the ASAE (2004) to determine the application rate, can be used to determine the flow rate, as follows.

$$Q = \frac{R \times S \times W}{R} \tag{1}$$

where,

Q, flow rate of particles from hopper, gm/sec

R, application rate, gm/ha

S, forward speed, m/sec

W, swath width, m

K, constant, 10<sup>4</sup> m<sup>2</sup>

• **Collecting trays:** Twenty collecting trays (Fig. 2) were put in a line on the ground for collecting broadcasted particles to construct broadcasting pattern of each broadcaster, performing broadcasting experiments and determining uniformity pattern specify the factors affecting on it. According to ASAE (2004), trays were put symmetrically in a row with equal distances to the longitudinal center line of the tractor. The distance between all trays was equal, except for the middle one which was bigger for making tractor wheels movement possible. Broadcasting started 30 m before trays row and continued to 40 m after trays row to put the tractor and the broadcaster in stable state [Alireza and Sheikhdavoodi (2012)].

• For calculated the uniformity of broadcasting: coefficient of variation-the statistical index was used

$$CV = \frac{\sigma}{\mu} \tag{2}$$

where,

CV= coefficient of variation(%)

σ = standard division of overlapped spread pattern

$$\{\sum(x_i - \bar{x})^2 / (N - 1)\}^{1/2}$$

**Table 1:** Summary of pattern urea fertilizer data.

Disc type	Disc speed RPM	Broadcast speed (km/h)	CV% Avg.	Swath width (m)	Bout width (m)	Field capacity (ha/h)
A1	405	4.10	27.7±0.2 f	21.5±0.1 b	18±0.1	7.32
		7.5	27.7±0.2 f	21±0.1 b	17±0.01	13.28
		12	26±1.1 e	19±0.1 c	14±0.1	16.83
	540	4.10	28.3±0.1 f	22.5±0.1 a	18±0.05	7.32
		7.5	27.7±1.2 f	22.5±0.1 a	18±0.05	14.06
		12	26.3±0.1 e	22±0.1 b	17±0.01	20.44
A2	450	4.10	23.7±1.2 d	22±0.1 b	19±0.05	7.73
		7.5	21.8±0.3 c	21.5±0.1 b	18±0.05	14.06
		12	20.5±1.0 a	20±0.1 c	16±0.05	19.24
	540	4.10	24±0.1 d	23.5±0.1 a	20±0.06	8.14
		7.5	21.4±0.3 b	23±0.1 a	19±0.01	14.84
		12	21±0.8 b	22.5±0.1 a	18±0.05	21.64

A1, A2: Spread disc types; CV%: Coefficient of variance of seed distribution for transverse line, similar letters, no significant difference between difference means and different letters, there is significant difference between difference means. The letters in columns about swath width, bout width and field capacity are showed affecting to disc speed and forward speed on it. The letters appear in the table columns for the data displaying the swath width, bout width and the field capacity, affecting the speed of the disc and the forward speed on it only.

$\mu$  = mean of overlapped spread pattern,

$X = \sum xi / N$ , is arithmetic mean

$xi$ , is accumulated sample weight for each collector  
 $N$ , number of collector locations used.

• Bout width and overlapped: Bout width was detected after choose a overlapped.

• **Broadcast Capacity:** Field capacity of broadcast spreader was calculated by the following expression:

$$C = \frac{S \times W}{K} \tag{3}$$

where,

$C$ , field capacity of spreader, ha/h

$S$ , ground speed, km/h

$W$ , Bout width, m

$K$ , constant, 10

• **Field experiments condition:** Ambient temperature (37°C), Ambient humidity ratio (18±0.3%), Wind speed (5.1±2.2 km/h), Ground slope (0.0%).

• **Measurements and statistical analysis:**

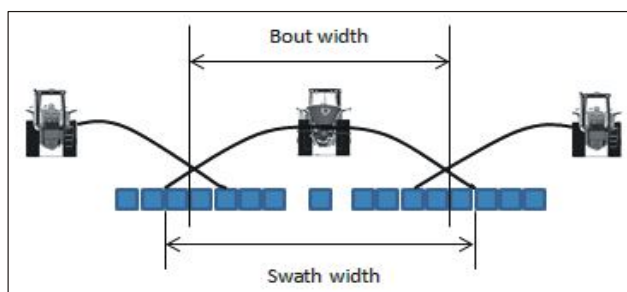

**Fig. 3:** Bout width and swath width with spread pattern

Collected particles sample being weighed on electronic scales, temperature and relative humidity of ambient air were measured by using mini thermo-anemometer and humidity device (±0.3%, ±1CO deg.).

The coefficient of variation (CV%) were analyzed to express particle distribution across the transverse line, the swath width, bout width and field capacity of the spreader according to the completely random design (CRD) and the preference between the means was detected by the Dunkin test.

### 3. Results and Discussion

The overlapped pattern was chosen at 20% of the swath width of the scattered urea fertilizer and 15% of swath width of barley. The coefficient of variation (CV%), widely used to characterize the quality of distribution uniformity in overlapped pattern. The results in Tables 1 and 2 show the coefficient of variation in

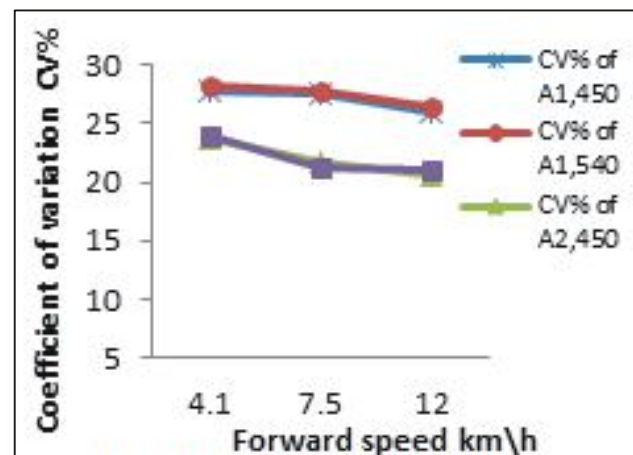

**Fig. 4:** Revaluation between forward speed and CV (%)

**Table 2:** Summary of barley seeds data.

Disc type	Disc speed RPM	Broadcast speed (km/h)	CV% Avg.	Swath width (m)	Bout width (m)	Field capacity (ha/h)
A1	405	4.10	27±0.1 f	16±0.1 d	14±0.2	7.32
		7.5	26.8±0.2 f	15±0.1 e	13±0.02	13.28
		12	25.3±1.3 e	14±0.15 f	12±0.1	16.83
	540	4.10	27.6±1.2 f	17±0.08 c	15±0.01	7.32
		7.5	27±1.2 f	17±0.05 c	15±0.05	14.06
		12	25.6±1.1 e	15±0.02	13±0.01	20.44
A2	450	4.10	22.2±1.2 d	17±0.06 c	15±0.05	7.73
		7.5	20.6±1.1 b	16.5±0.01 c	14±0.03	14.06
		12	18.6±1.2 a	15±0.01 e	13±0.05	19.24
	540	4.10	22.5±0.1 d	19±0.01 a	17±0.05	8.14
		7.5	21±1.3 c	18±0.06 b	16±0.01	14.84
		12	19.7±1.1 c	16±0.05 d	14±0.02	21.64

A1, A2: Spread disc types; CV%: Coefficient of variance of seed distribution for transverse line, similar letters, no significant difference between difference means and different letters, there is significant difference between difference means. The letters in columns about swath width, bout width and field capacity are showed affecting to disc speed and forward speed on it. The letters appear in the table columns for the data displaying the swath width, bout width and the field capacity, affecting the speed of the disc and the forward speed on it only.

the cross-distribution pattern at this percentage of the overlapped pattern when using two types of discs A<sub>1</sub>, A<sub>2</sub> with different disc speed and forward speed.

ANOVA results for urea fertilizer and barley data indicated that there are significant differences (p < 0.005) in the coefficient of variation due to the type of disc, as the coefficient of variation decreased due to the use of disc A<sub>2</sub> while there was no significant effect of the disc type on swath width, bout width and field capacity. We note the superiority of treatment A<sub>2</sub> with urea where the lowest coefficients of difference were 20.5 % compared to A<sub>1</sub> (26.3%) (Table 1) and the superiority of treatment A<sub>2</sub> with barley where the lowest coefficients of difference were 18.6% compared to A<sub>1</sub> (25.3%) (Table 2). However, according to Dan

Bloomer (2020) these results are acceptable if the device is used to grow barley, but it is considered poor in the case of nitrogen fertilizers such as urea. Fertilizer recommendations which states that 15-20% CV is a poor ratio compared to 10-15% CV, which is good, using a higher interference rate may improve the results. On the other hand, we find that the forward speed affected the coefficient of difference, swath width and field capacity below the level of significance (p < 0.005) (Tables 1 & 2).

Figs. 4,5,7 and 8 showed the reevaluation between forward speed and CV, bout width. The CV value improves as it decreases as the forward speed of the machine increases, while the width decreases, meaning it deteriorates as the forward speed increases. Figs. 6 and 9 show the increase in field capacity when increasing the forward speed. Tables 1 and 2 show

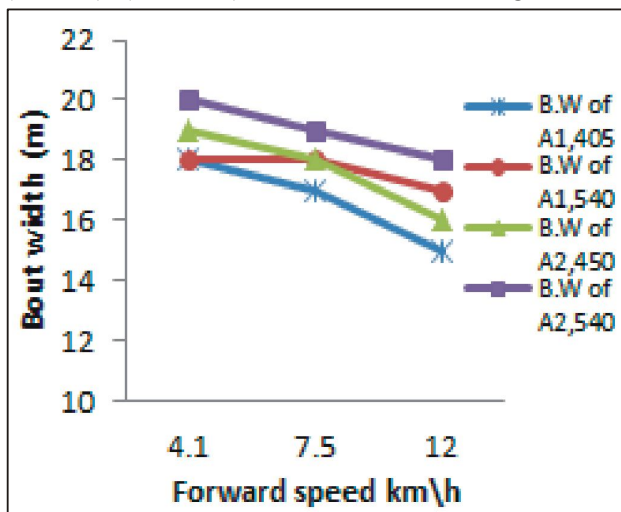

**Fig. 5:** Reevaluation between forward speed and bout width (urea)

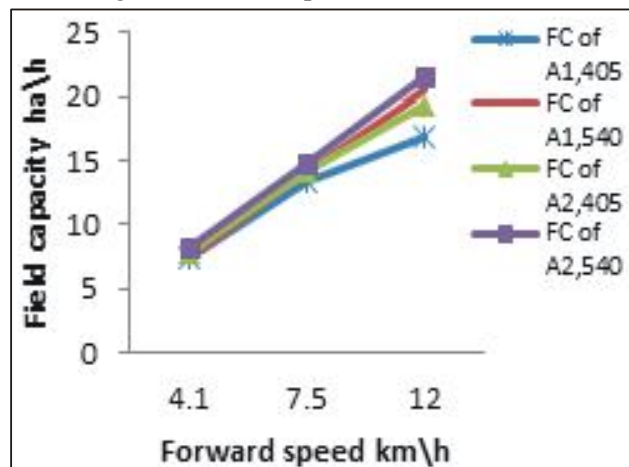

**Fig. 6:** Reevaluation between forward speed and FC (urea)

that the field capacity improves when using the A<sub>2</sub> disc and the forward speed is 12 km/hour despite the decrease in swath width and bout width by increasing the forward speed and increasing the speed of the disc.

From Tables 1 and 2 we find that the speed of the disc did not affect the CV and the field capacity under

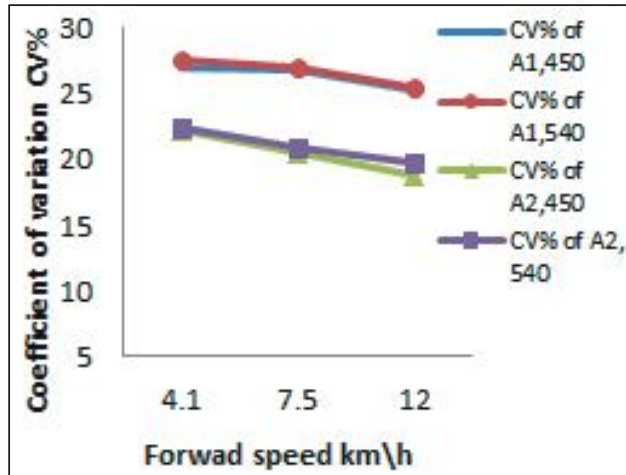

Fig. 7: Reevaluation between forward speed and CV (Barley)

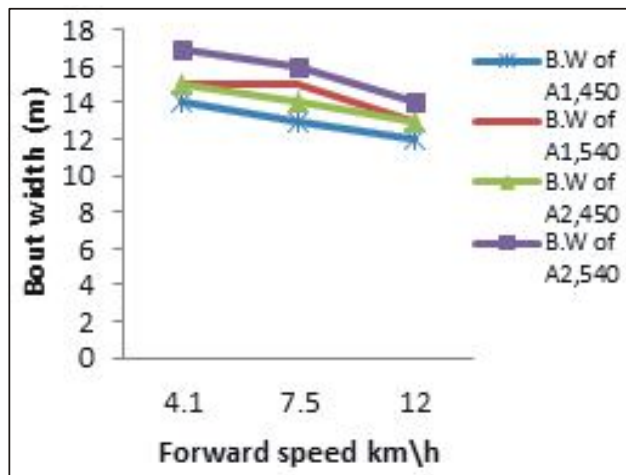

Fig. 8: Reevaluation between forward speed and B.w. (Barley)

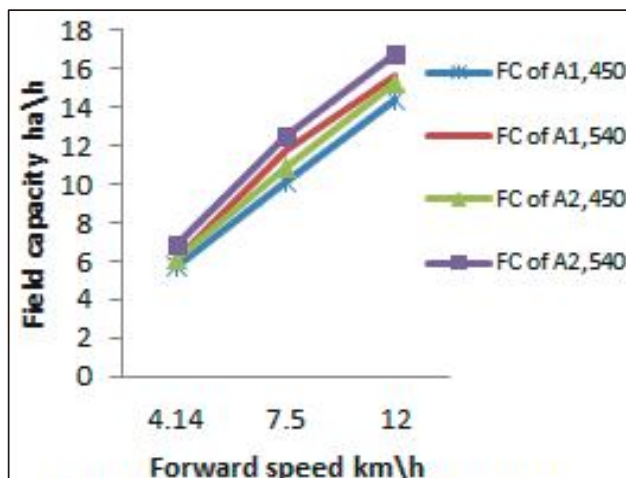

Fig. 9: Reevaluation between forward speed and FC

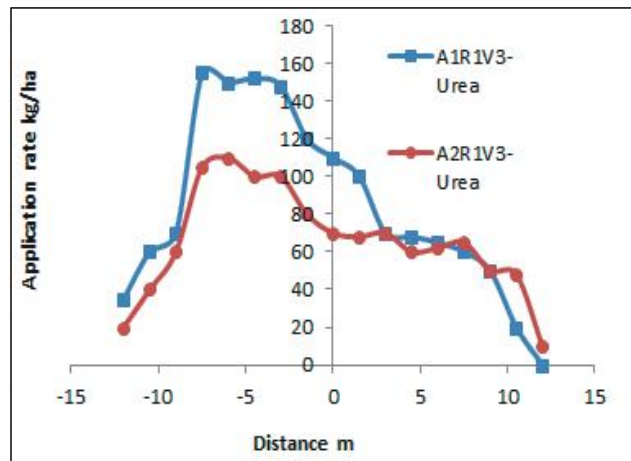

Fig. 10: Compare spray pattern of urea at optimum spray condition by A1 disc and A2 disc

the level of significance ( $< 0.05$ ) while we note the presence of an effect on swath width and bout width. This result is inconsistent with results of Jiman *et al.* (2018) and Yildiran and Mazhar (2020), Perhaps the reason is since their studies were carried out at a speed higher than 540 rpm and did not take into account the effect of the forward speed on the width. We notes that the CV decreases as the bout width increases.

Figs. 10 and 11 show a comparison between the ideal performance of disc A<sub>2</sub> and disc A<sub>1</sub> at forward speed 12 km/h by drawing the distribution pattern between bout width and application rate. We notice from these figures an improved distribution when using disc A<sub>2</sub> compared to disk A<sub>1</sub>. Likewise, performance improved when using disc A<sub>2</sub> for barley seed scattering, as it recorded 18.6% of CV compared to urea scattering 20.5 of CV, note that Table 1 compared to the data of Table 2 and from Fig. 1 against Fig. 2.

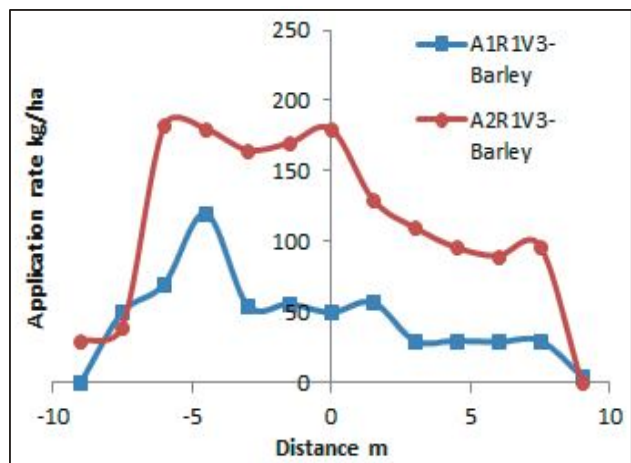

Fig. 11: Compare spray pattern of Barley at optimum spray condition by A1 disc and A2 disc

#### 4. Conclusions

- The use of disc A<sub>2</sub> reduces the coefficient of variation (CV%). The machine reached its best performance when using the forward speed of 12 km/h and the speed of the disc 450 rpm where the CV% decreased by 5.5 and 7.6 of A<sub>2</sub> disc of barley and urea, respectively.

- The forward speed of the machine has a greater effect than the speed of the disc on the CV.

- The coefficient of variation decreases when the swath width and bout width decreases.

- There is an inverse relationship between the forward speed and the CV, swath width and bout width, while the relationship is direct with the field capacity.

- There is an effect of the disc speed of 450-540 rpm on the swath and bout width and no effect on the CV.

- The distribution of scattered particles can be improved by developing a scattering disc and taking advantage of high forward speeds rather than focusing on increasing the swath width.

#### References

- Abubakar, M.S. and D. Ahmad (2012). Distribution pattern assessment of a dual-purpose disc agrochemical applicator for field crops. *Journal of Engineering, Technology and Environment*, **8**, 1-13.
- Alireza, S. and M.J. Sheikhdavoodi (2012). Evaluating of broadcasting uniformity of centrifugal and oscillating granular broadcasters. *Journal of Applied Sciences Engineering and Technology*, **4(15)**, 2460-2468
- ASAE (2004). Standards S341.2. 45th Ed., 2004. Procedure for measuring distribution uniformity and calibrating granular broadcast spreaders. ASAE, St. Joseph, MI.
- Dan Bloomer (2020). Broadcast Fertiliser Applicator Performance Assessment. Training Handbook, Land WISE Inc., Centre for Land and Water 21 Ruahapia Rd Hastings, NZ 4180, 24.
- Grafton, M.C.E., I.J. Yule, B.G. Robertson, S.E. Chok and M.J. Manning (2015). Ballistic modeling and pattern testing to prevent separation of newzealand fertilizer products. Hofstee, J.W. (1995). Handling and spreading of fertilisers, Part 5: the spinning disc type fertiliser spreader. *Journal of Agricultural Engineering Research*, **62(3)**, 143-162.
- Ian, Y. and M. Grafton (2016). A review of spreading accuracy from twin disc fertilizer spreaders. Draft Report to Fertiliser Quality Council, New Zealand Centre for Precision Agriculture, Massey University.
- JiMan, K., W. Dukgam and K. Taehan (2018). Analysis on fertilizer application uniformity of centrifugal fertilizer distributor. *J. Biosyst. Eng.*, **43(4)**, 420-425.
- Lawrence, H.G., I.J. Yule and J.R. Jones (2006). A statistical analysis of international test methods used for analyzing spreader performance. *New Zealand Journal of Agricultural Research*, **49(4)**, 451-463. DOI: 10.1080/00288233.2006.9513736.
- Przystupa, W., M. Kostrzewa and M. Murmyto (2016). A unified model of a spinning disc centrifugal spreader. *Econtechmod. an international quarterly journal*, **5(3)**, 123-130.
- Tomantschger, K., V.D. Petrovic, B.V. Cerovic, Z.A. Dimitrijevic and L.R. Radojevic (2018). Prediction of a fertilizer particle motion along a vane of a centrifugal spreader disc assuming its pure rolling. *FME Transactions*, **46**, 544-551.
- Vera, B.C., V.P. Dragan, L.R. Rade, R.B. Sasa and V. Aleksandar (2018). On the fertilizer particle motion along the vane of a centrifugal spreader disc assuming pure sliding of the particle. *Journal of Agricultural Sciences*, **63(1)**, 83-97.
- Wilson, T.P. and M.C.E. Grafton (2019). Demonstrating the compatibility of a new spreadmark test with the current method. In: Nutrient loss mitigations for compliance in agriculture. (Eds. L.D. Currie and C.L. Christensen). <http://flrc.massey.ac.nz/publications.html>. Occasional Report No. 32. Fertilizer and Lime. Research centre, Massey University, Palmerston North, New Zealand.
- Yildiran, Y. (2020). Effect of cone angle and revolution speed of disc on fertilizer distribution uniformity in Single-disc rotary fertilizer spreaders. *Journal of Applied Sciences*, **6**, 2875-2881.
- Yildiran, Y. and K. Mazhar (2012). Effect of Different Vane Combinations on Fertilizer Distribution Uniformity with Various Flow Rates in Spinning Disc Broadcasters. *Journal of Agricultural Sciences*, **18**, 54-64.